

Operator Manual

Mobile Printer

PW208NX / PW208mNX

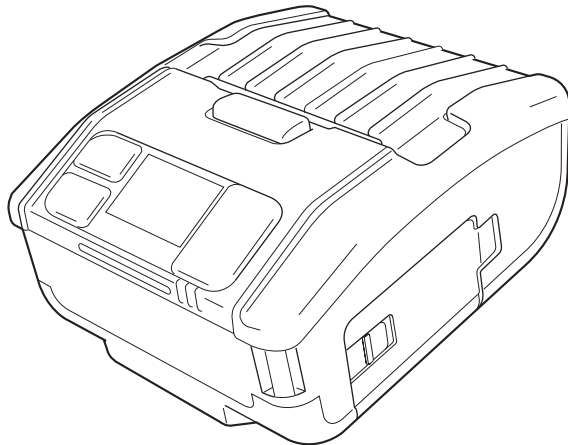
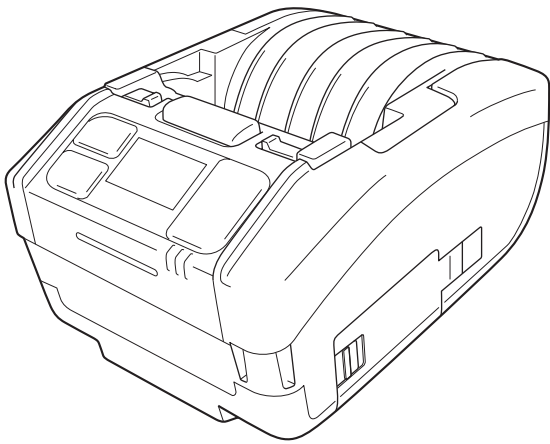

Preface

Thank you for purchasing PW208NX/PW208mNX mobile printer (hereafter “the printer”).

This manual supplies basic information on how to operate the printer in a short period.

Read the manual carefully to understand each function before use.

The pictures and submenu screens in this manual show the PW208NX printer, unless otherwise stated. For the PW208mNX, some of them may differ, but the basic operations are the same.

Because of changes in specifications, the pictures and submenu screens in this manual may differ from those actually displayed in the printer.

Notes

- (1) Any unauthorized reproduction of the contents of this document, in part or whole, is strictly prohibited.
- (2) Specifications and contents in this document are subject to change without notice.

Use only the supply products specified by SATO.

Notice on registered trademarks or trademarks of other companies

- QR Code is a registered trademark of DENSO WAVE INCORPORATED.
- Wi-Fi® is a registered trademark of Wi-Fi Alliance.
- Wi-Fi Direct™, Wi-Fi Protected Setup™, WPA™ and WPA2™ are registered trademarks of Wi-Fi Alliance.
- iOS is a trademark or a registered trademark of Cisco Corporation in the U.S. or other countries, and used based on the license.
- Bluetooth is a trademark of Bluetooth SIG, Inc., U.S.A. Any use of Bluetooth word mark and logos by SATO Corporation is under license agreement with the Bluetooth SIG.

Regulatory Approval

You are cautioned that changes or modifications not expressly approved by the party responsible for compliance could void your authority to operate the equipment.

This device complies with Part 15 of the FCC Rules. Operation is subject to the following two conditions: (1) this device may not cause harmful interference, and (2) this device must accept any interference received, including interference that may cause undesired operation.

This equipment has been tested and found to comply with the limits for a Class B digital device, pursuant to Part 15 of the FCC Rules. These limits are designed to provide reasonable protection against harmful interference in a residential installation. This equipment generates, uses and can radiate radio frequency energy and, if not installed and used in accordance with the instructions, may cause harmful interference to radio communications.

However, there is no guarantee that interference will not occur in a particular installation.

If this equipment does cause harmful interference to radio or television reception, which can be determined by turning the equipment off and on, the user is encouraged to try to correct the interference by one or more of the following measures:

- Reorient or relocate the receiving antenna.
- Increase the separation between the equipment and the receiver.
- Connect the equipment into an outlet on a circuit different from that to which the receiver is connected.
- Consult the dealer or an experienced radio/TV technician for help.

Shielded cable must be used in order to comply with the emission limits.



WARNING Disposal of Old Electrical & Electronic Equipment (Applicable in the European Union and other European countries with separate collection systems)

A product marked with this symbol on itself or on its packaging shall not be treated as household waste. Instead it shall be handed over to an appropriate collection point for the recycling of electrical and electronic equipment in accordance with local regulations.

Inappropriate waste handling of this product may cause detrimental consequences for the environment and damage to human health. The recycling of materials will help to conserve natural resources and contribute to your community.

For more detailed information on recycling of this product, please contact your local municipal organization, your household waste disposal service or the dealer where you purchased the product.

① Under the following environments, this device may cause radio interference, which may result in a delay in printing or even disable printing.

Examples:

- Environment where industrial, scientific, or medical equipment (e.g.: microwave oven) is used.
- Environment where a premises radio station or specified low power radio station is located around the device.
- Environment where there are many metal products.

② Network connection may become unstable depending on the radio environment. If it becomes unstable, perform retry processing or other countermeasure with the application you are using.



Bluetooth is a trademark of Bluetooth SIG, Inc., U.S.A.

Any use of Bluetooth word mark and logos by SATO Corporation is under license agreement with the Bluetooth SIG.

Wi-Fi Certified



Table of Contents

Precautions on Safety	3
Precautions for Handling	10
Checking the Supplied Accessories	11
1 Before You Start	12
1.1 Parts Identification	12
1.2 Charging the Battery	14
1.2.1 Inserting the Battery	14
1.2.2 Charging with AC Adapter (Optional)	15
1.2.3 Charging with Charging Cradle (Optional)	15
1.2.4 Charging with Battery Charger (Optional)	18
1.3 Loading the Media	19
1.4 Display	20
1.4.1 Normal Mode.....	20
1.4.2 Error Message Mode.....	20
1.4.3 Settings Mode	20
1.5 Icon	21
1.5.1 Status Icon	21
1.5.2 Error Icon.....	25
1.6 LED Lighting Pattern	27
1.6.1 Normal Mode.....	28
1.6.2 Energy Saving Mode	29
1.7 Dispenser Mode (PW208NX only)	30
1.7.1 Switching to the Dispenser Mode.....	30
1.7.2 Switching Mode from the Dispenser Mode.....	31
2 Starting Up the Printer	32
2.1 Printer Startup and Power Off	32
2.1.1 Printer Startup	32
2.1.2 Printer Power Off.....	33
2.2 Normal Mode	34
2.2.1 Online (Ready to Print) and Printing.....	34
2.2.2 Offline (Stop) and Pause (Stop Printing)	35
2.2.3 Canceling Print Job	35
2.3 Adjustment Mode	36
2.3.1 Screen Transition for Adjustment Mode	36
2.4 Settings Mode	37
2.4.1 Log In to the Settings Mode	37
2.4.2 Operations in Settings Mode Screens.....	38
2.4.3 Identifying the Submenus.....	39
2.4.4 Setting Screen (Value Input)	40
2.4.5 Setting Screen (Setting Item)	41

2.5 Settings Menu Tree Structure	42
2.6 Details of the Settings Menu Screen	50
2.6.1 Printing Menu	50
2.6.2 Interface Menu	68
2.6.3 Battery Menu	88
2.6.4 Applications Menu	90
2.6.5 System Menu	98
2.6.6 Tools Menu	108
2.6.7 Information Menu	119
2.7 List of Initial Value.....	122
2.7.1 Printing Menu	122
2.7.2 Interface Menu	124
2.7.3 Battery Menu	127
2.7.4 Applications Menu	127
2.7.5 System Menu	128
2.7.6 Tools Menu	129
3 Troubleshooting	130
3.1 Error Message Mode.....	130
3.1.1 Error Messages.....	130
3.1.2 Status LED Indicator	130
3.1.3 Error Buzzer Sound.....	130
3.2 Error List.....	131
3.2.1 How to See the Command Error Information	136
3.3 List of Warning Icons.....	138
3.4 Notifications	139
4 Optional Accessories	140
5 Cleaning the Printer	141
Platen Roller.....	141
Print Head	141
Media Guide.....	141
6 Basic Specifications.....	142
6.1 Printer Specifications	142
6.2 Media Specifications.....	147
6.3 Charging Cradle (Optional) Specifications.....	148
7 Support.....	149

Safety Precautions

Precautions on Safety

This section describes how to safely operate the printer. Be sure to read and understand all instructions carefully before you install and use the printer.

Pictographic Symbols

This operator manual and printer labels use a variety of pictographic symbols. These symbols show the safe and correct operation of the printer and how to prevent injury to others and property damage. The symbol explanations are as follows.

 Warning	Ignoring the instructions marked by this symbol and erroneously operating the printer could result in death or serious injury.
---	--

 Caution	Ignoring the instructions marked by this symbol and erroneously operating the printer could result in injury or property damage.
---	--

Pictographic Symbols





















The \triangle pictograph means “Caution is required”. The pictograph includes a specified warning symbol (for example, the left symbol shows electric shock).



















The \circ pictograph means “Must not be done”. The pictograph includes a specified prohibited symbol (for example, the left symbol means “Disassembly prohibited”).



The \bullet pictograph means “Must be done”. The pictograph includes a specified mandate action symbol (for example, the left symbol means “Disconnect the power plug from the outlet”).

 WARNING	
 	<ul style="list-style-type: none"> ■ Do not use other than the specified voltage • Do not use other than the specified voltage. Doing so could result in fire or electric shock.
  	<ul style="list-style-type: none"> ■ Do not put objects inside the product • Do not insert or drop in metal or burnable objects inside the product's openings (cable outlets, etc.). If foreign objects do get inside the product, immediately turn off the power switch, unplug the power cord from the outlet, and contact your SATO reseller or technical support center. Using the product in this condition could cause a fire or electric shock.
  	<ul style="list-style-type: none"> ■ Handling the power cord • Do not damage, break, or modify the power cord. Also, do not place heavy objects on the power cord, heat it, or pull it because doing so could damage the power cord and cause a fire or electric shock. • If the power cord becomes damaged (core is exposed, wires broken, etc.), contact your SATO reseller or technical support center. Using the power cord in this condition could cause a fire or electric shock. • Do not modify, excessively bend, twist, or pull the power cord. Using the power cord in such a condition could cause a fire or electric shock.
  	<ul style="list-style-type: none"> ■ When the product has been dropped or broken • If the product is dropped or broken, immediately turn off the power switch, unplug the power cord from the outlet, and contact your SATO reseller or technical support center. Using the product in this condition could cause a fire or electric shock.
 	<ul style="list-style-type: none"> ■ Do not use the product when something is abnormal about it • Continuing to use the product in the event something is abnormal about it, such as smoke or unusual smells coming from it, could result in fire or electric shock. Immediately turn off the power switch, unplug the power cord from the outlet, and contact your SATO reseller or technical support center for repairs. It is dangerous for the customer to try to repair it, so absolutely do not attempt repairs on your own.
	<ul style="list-style-type: none"> ■ Do not use in hazardous locations • The product is not explosion proof certified. Do not use in a potentially explosive environment or atmosphere.
	<ul style="list-style-type: none"> ■ Do not set on an unstable area • Do not set on an unstable area, such as a wobbly table or slanted area or an area subject to strong vibration. If the product falls off or topples over, it could injure someone.
  	<ul style="list-style-type: none"> ■ Do not place containers full of water or other liquid on the product • Do not place flower vases, cups, or other containers holding liquids, such as water or chemicals, or small metal objects near the product. If they are spilled and get inside the product, immediately turn off the power switch, unplug the power cord from the outlet, and contact your SATO reseller or technical support center. Using the product in this condition could cause a fire or electric shock.

WARNING

	<ul style="list-style-type: none"> ■ Connecting optional cables or optional devices • Before connecting an optional cable or device to the product, make sure to turn off the power switch of the product and the optional devices. If they are connected with the power on, an optional device may move unexpectedly or other unexpected occasions may occur, resulting in injuries, electric shock, or malfunctions. • When installing the optional cable or optional devices, make sure not to make a mistake in the orientation and steps to install. Doing so could result in a fire, injuries or malfunctions. • Do not use other than the supplied cables or specified optional cables. Doing so could result in smoke from the cable, a fire or a malfunction.
  	<ul style="list-style-type: none"> ■ AC adapter/Battery charger (optional)/Charging cradle (optional) • Use only the specified AC adapter/battery charger/charging cradle. Using a different one may create the danger of fire or electric shock. • Never use the battery charger with any other battery pack except for the specified one. Doing so can rupture the battery, cause leakage, fire or electric shock.
 	<ul style="list-style-type: none"> ■ Handling the AC adapter • Do not damage, break, or change the AC adapter. If you place a heavy object on the AC adapter or heat, bend too much, twist, or pull the AC adapter, the AC adapter may be damaged, which may cause fire or electric shock. • If the AC adapter is damaged (the wires exposed or broken), contact your SATO reseller or technical support center. If you operate the product in this condition, it may cause fire or electric shock.
   	<ul style="list-style-type: none"> ■ Battery Pack • Never try to take apart the battery pack or modify it in any way such as with a solder iron. • Never expose the battery to direct flame, throw it into fire, or take any actions that may lead to shorting. • When charging the battery pack, make sure to use the product or the specified battery charger. • Do not allow the battery to get wet with water or any liquid. • Do not throw or drop the battery to avoid damage. • If you notice any unusual odor, deformation, fluid leakage or other unusual conditions during use, charging or storage, stop using the battery to avoid risk of fire, personal injury and electric shock.
 	<ul style="list-style-type: none"> ■ Do not disassemble the product • Do not disassemble or modify the product. Doing so could result in fire or electric shock. Ask your SATO reseller or technical support center to conduct internal inspections, adjustments, and repairs.
	<ul style="list-style-type: none"> ■ Regarding the cutter • Do not touch the cutter with your hands or do not put something into the cutter. Doing so could result in an injury.
 	<ul style="list-style-type: none"> ■ Do not operate with wet hands • Do not operate the power switch, replace the battery pack or unplug the AC adapter with wet hands. Doing so increases the risk of electric shock.
 	<ul style="list-style-type: none"> ■ Using the head cleaning fluid • Use of flame or heat around the head cleaning fluid is prohibited. Absolutely do not heat it or subject it to flames. • Keep the fluid out of reach of children to prevent them from accidentally drinking it. If a child accidentally drinks the fluid, immediately consult with a physician.

WARNING

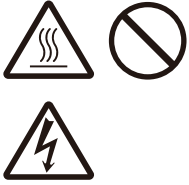

- **Print head**
 - The print head is hot after printing. Be careful not to get burned when replacing media or cleaning immediately after printing.
 - Touching the edge of the print head with bare hands could result in injury. Be careful not to become injured when replacing media or cleaning.
 - The customer should not replace the print head. Doing so could result in injury, burns or electric shock.

CAUTION



- **Do not place in areas with high humidity**
 - Do not place the product in areas with high humidity or where condensation forms. If condensation forms, immediately turn off the power switch and do not use the product until it dries. Using the product while condensation is on it could result in electric shock.

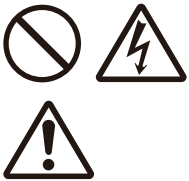

- **Power supply**
 - An AC adapter may become hot. Be careful not to get burned.
 - An AC adapter (Optional) is exclusive for this product. It must not be used with any other electric device.
 - When disconnecting an AC adapter from the outlet, be sure to grip it by the plug. Pulling on the cord may expose or break the wires and possibly cause fire or electric shock.
 - Do not put an AC adapter near a hot device. Leaving an AC adapter near a hot device could cause the adapter's housing to melt and possibly cause fire or electric shock.

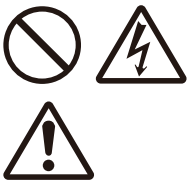

- **Power cord and cable**
 - When disconnecting a power cord or cable from the outlet, be sure to grip it by the plug. Pulling on the cord or cable may expose or break the wires and possibly cause fire or electric shock.
 - Do not put a power cord or cable near a hot device. Leaving a power cord or cable near a hot device could cause the cord's or cable's housing to melt and possibly cause fire or electric shock.



- **Handling an AC adapter (Optional) when moving**
 - On the occasion of carrying, first disconnect an AC adapter from the outlet. If an AC adapter is not disconnected, it may be damaged, which may cause a fire or electric shock.

⚠ CAUTION

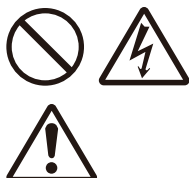

■ Replacing the Battery Pack

- Use only the specified battery pack.
- When replacing the battery pack, make sure to install the pack in the correct orientation. Incorrectly replacing the battery creates the danger of injury or damage to surrounding areas, or causes explosion.
- Replace with a small-size rechargeable battery (Lithium ion battery). Apply insulation treatment to the old battery pack by sealing the contact with tape or the like and ask our sales representative or service center for the measures to be taken to recycle the reusable materials.
Do not place the battery pack together with other batteries such as dry batteries.
- The life expectancy of the lithium ion battery pack varies depending on usage. We recommend that you replace the battery after 300 charge cycles or 3 years from the date of first use, whichever comes first.
- If you notice any dents or cracks on your battery crust caused by strong impacts or shocks, stop using the battery immediately and replace it with a new one.
Continued use under these conditions may lead to abnormal overheating or fire.



■ Loading media

- When loading media roll, be careful not to get your fingers pinched between the media roll and the supply unit.



■ Top cover

- Be careful not to get your fingers pinched when opening or closing the top cover. Also be careful the top cover does not slip off and drop.



■ When not using the product for a long time

- When not using the product for a long time, unplug the AC adapter from the outlet to maintain safety.















■ During maintenance and cleaning

- When maintaining and cleaning the product, remove the battery pack from the product and unplug the AC adapter from the outlet to maintain safety.

Safety Precautions on Batteries

The lithium-ion battery pack (hereafter called the battery) has a certain life expectancy depending on the usage. Please change the battery when its operating time has become much shorter than usual. As the battery life wears out, problems such as smeared prints or reduced output performance may occur. Make sure to change the battery regularly. Always observe the following safety precautions for battery use. Mishandling the battery may cause electric shock, battery leakage, overheating, smoke, rupture, or fire.

 WARNING	
	The life expectancy of the lithium ion battery pack ("battery") varies depending on usage. We recommend that you replace the battery after 300 charge cycles or 3 years from the date of first use, whichever is earlier.
	If you notice any dents or cracks on your battery crust caused by strong impacts or shocks, stop using the battery immediately and replace it with a new one. Continued use under these conditions may lead to abnormal overheating or fire.
	Do not disassemble or modify the battery.
	When charging the battery as fitted in the product, use an AC adapter specified by SATO Corporation.
	Do not place the battery in fire, or apply heat to the battery.
	Do not place the battery near fires, stoves, or other high-temperature locations (above 60°C (140 °F)) such as inside closed cars in hot weather.
	Do not charge or discharge the battery near flammable materials.
	Do not connect the positive (+) and negative (-) terminal of the battery with any conductive materials such as metal wires. Do not carry or store the battery together with necklaces, hairpins, or other metal objects to prevent accidental short-circuiting of the battery.
	When connecting the battery to an AC outlet, a car cigarette lighter outlet or the like, always use the dedicated charger.
	Do not wet or immerse the battery in water, seawater, or other liquids.
	Do not throw or drop the battery, subjecting it to strong impacts or shocks.
	Do not pierce the battery with sharp objects such as nails, strike the battery with a hammer, or step on the battery.

WARNING



Do not rub your eyes if the battery liquid leaks and comes into contact with your eyes. Rinse well with clean water such as tap water, and seek medical attention immediately.



If charging is not completed after the specified time elapses, remove the battery from the product or charger and stop charging.



If you notice any unusual odor, heat, discoloration, deformation, fluid leakage or any other characteristic apart from what you are used to while using, charging or storing the battery, then perform the following immediately.

- Unplug the power cord from the AC outlet.
- Power off the product.
- Remove the battery from the product or charger. Keep the battery away from fire and avoid using it. Otherwise, there may result in fire, burn, injury, or electric shock.

CAUTION



Charge the battery in the recommended temperature range from 5°C to 35°C (41 to 95 °F).



Store the battery in a location out of reach of young children. Ensure that the battery is not placed in the mouth or swallowed accidentally.



Occasionally clean the terminal by wiping with a dry cotton swab or the like.



When storing the battery, avoid storing in the following state.

- In a fully charged state (a state immediately following the completion of charging)
 - In a state with no remaining capacity (the battery is so exhausted that it is even impossible to turn on the product)
- Doing so may result in a degraded battery performance or reduced lifetime. An optimal remaining capacity to store the battery is approximately 40%.



Even when the battery is expected not to be used for a long time, do the following about every six months to enable the battery to maintain its performance: fully charge the battery and use it to drive your product until its remaining capacity decreases to approximately 40%, then remove the battery from the product and store it in a cool room with low humidity.

A tip before use

If you write down the start date on the “Start Date” column on the sticker on the battery, you will know when to replace the battery.

Precautions for Handling

Place the printer on a surface that is flat and level.

- Do not place the printer in an unlevel or slanted place.
Doing so could cause falling.

Do not put the printer on a location that produces vibration.

- When keeping the printer, avoid a location subject to vibration.

Keep the printer out of high temperature and humidity.

- When using or keeping the printer, avoid a location with high temperature or humidity. High temperature and humidity may cause the decrease of life span of the printer. (Recommended temperature: 10 to 30°C (50 to 86°F))

Avoid dust.

- Do not put the printer on a location exposed to dust. It may cause failure or the decrease of life span of the printer.

Do not supply power near from a heater or refrigerator.

- Do not supply power from the power source near an electrical device that requires a measurable amount of power.
Voltage reduction may cause malfunction or defect.

Checking the Supplied Accessories

Check the supplied accessories.

If there are missing items, contact your SATO reseller or technical support center.

Battery

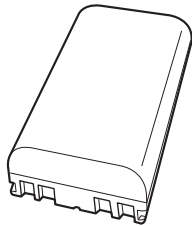

Global Warranty
Program leaflet

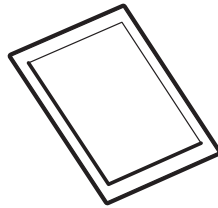

BD Address sticker

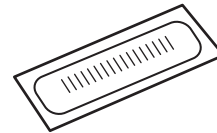

Quick Guide
Download Guide
Safety Instructions
MFi License Information

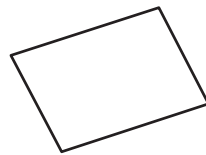

Belt clip (One pair)
(PW208NX only)

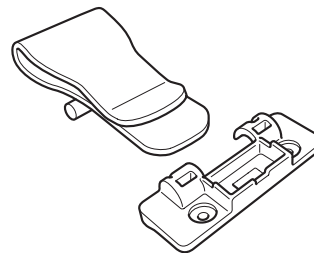

Screws (2)
(PW208NX only)



* AC adapter is optional.

▲ Keep the Warranty and Packaging

The printer is guaranteed for six months after installation for normal operation, and repair is free of charge.

Keep the packaging box and cushioning material for this printer. When requesting repairs, pack the printer in the original box with the original padding for shipment.

1

Before You Start

1.1 Parts Identification

PW208NX

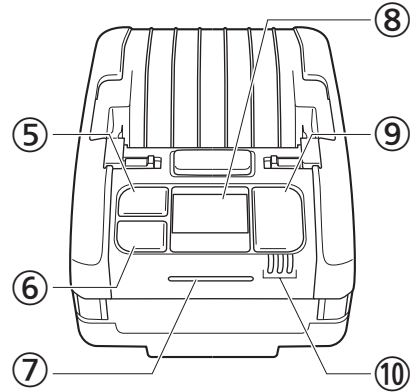
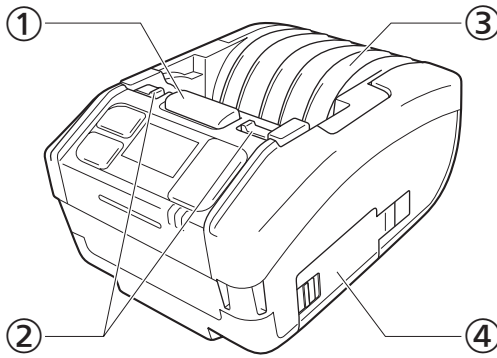

PW208mNX

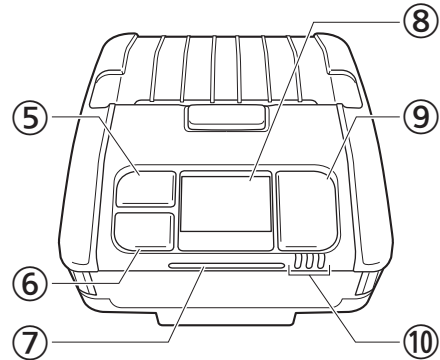
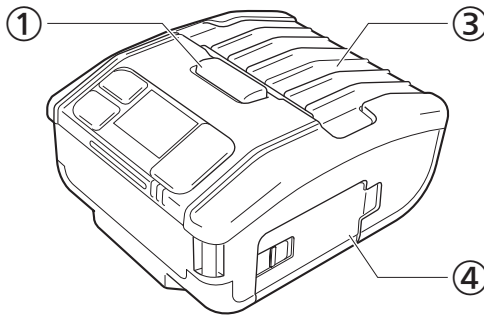

- ① Cover open button
- ② Dispenser mode switch lever (PW208NX only)
- ③ Top cover
- ④ Battery cover
- ⑤  (Media feed/Enter) button
- ⑥  (Print/Select) button
- ⑦ Status LED indicator
- ⑧ Display
- ⑨  (Power) button
- ⑩ Battery level LED indicator

PW208NX

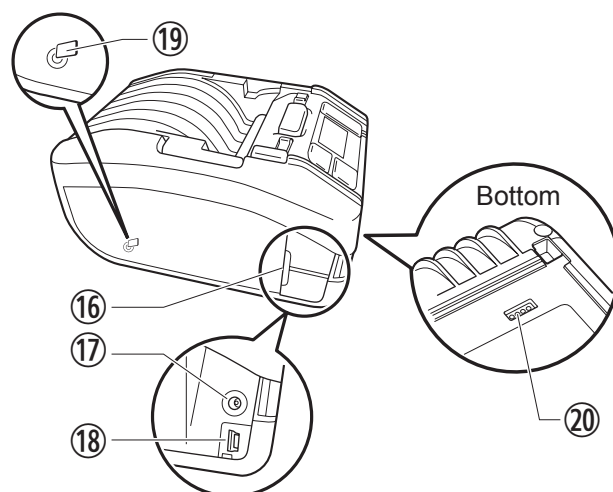
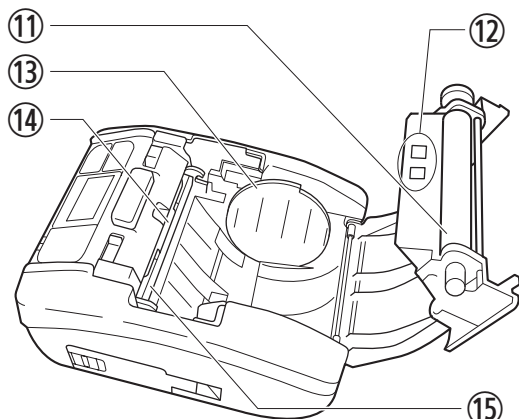

PW208mNX

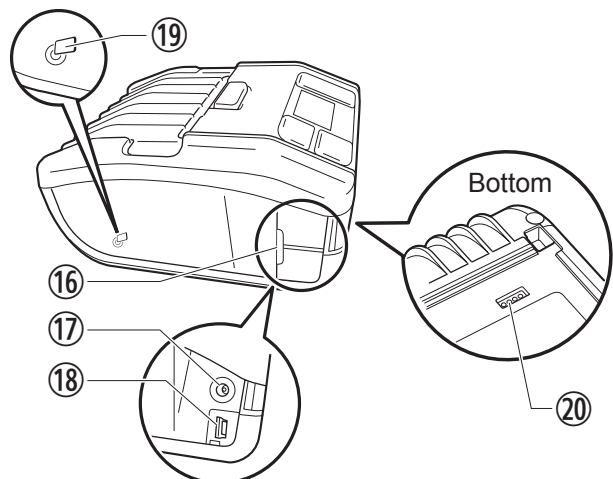
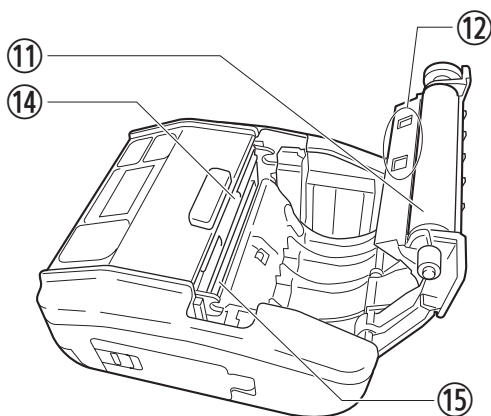

- | | |
|---|---|
| <ul style="list-style-type: none"> ⑪ Platen roller (Consumables) ⑫ Media sensors ⑬ Media guide (PW208NX only) ⑭ Cutter ⑮ Print head (Consumables) ⑯ Interface cover | <ul style="list-style-type: none"> ⑰ DC input connector (AC power connector) ⑱ USB connector ⑲ NFC internal antenna ⑳ Charging terminal for a Charging Cradle (Optional)
When the printer is shipped from the factory, a black protective seal labeled "CRADLE ACCESS" is affixed to the terminal. When using a cradle to charge the printer, remove this seal. |
|---|---|

* The platen roller feeds the label roll.
The print head prints on the label roll.
Perform maintenance regularly, as these parts are for printing. (👉 [page 141](#))



• The cutter has the blade edge. Be careful not to get cut your finger.

1.2 Charging the Battery

Before using the printer, use the following charging device to charge the supplied battery.

- AC adapter: “1.2.2 Charging with AC Adapter (Optional)” (☞ page 15)
- Charging cradle: “1.2.3 Charging with Charging Cradle (Optional)” (☞ page 15)
- Battery charger: “1.2.4 Charging with Battery Charger (Optional)” (☞ page 18)



- An AC adapter (Optional) and Charging cradle (Optional) are for this printer only. It must not be used with any other electric device. If an AC adapter other than the specified one is connected to this printer, it may cause a malfunction. Do not use it.
- If the battery has not been charged for a long period of time, it may become unusable. Charge the battery regularly.

1.2.1 Inserting the Battery

Power off the printer before inserting or removing the battery.

1

Open the battery cover.

Slide the lever of the battery cover (①).

Open the battery cover (②).

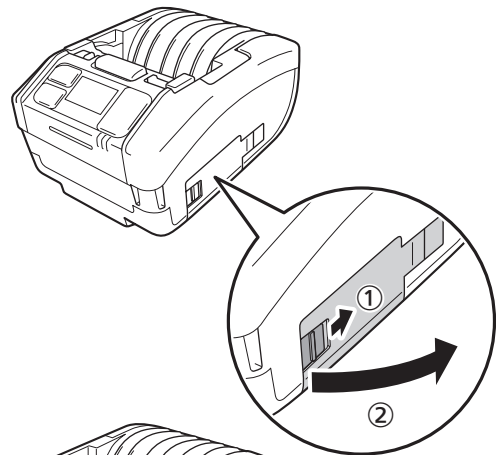

2

Insert the battery.

Insert the battery from the metal side.

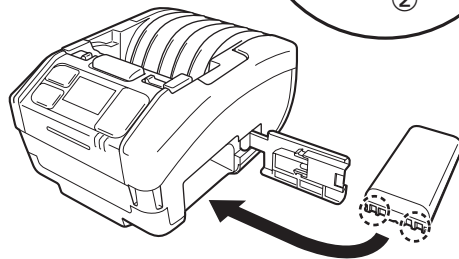

3

Close the cover.

Close the battery cover (①).

Slide the lever of the battery cover with the battery cover pressed shut (②).

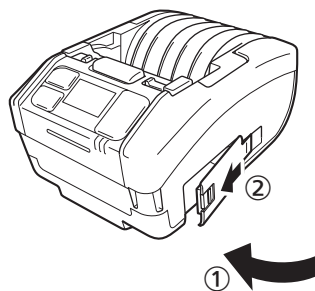

1.2.2 Charging with AC Adapter (Optional)

1 Connect the AC adapter (Optional).

Open the interface cover.

Connect the DC plug to the printer and the AC power plug to the AC outlet.

* The shape of power plug varies depending on the region.

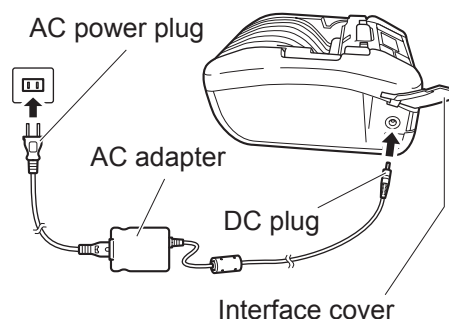

2 Charging starts.

During charging, do not power off the printer.

For details on the display during charging, see "Icon" ([page 23](#)).

1.2.3 Charging with Charging Cradle (Optional)

There are two types of charging cradles: 1Bay Charging Cradle for charging one printer, and 4Bay Charging Cradle for charging four printers simultaneously ([page 140](#)).

This section describes how to use the 1Bay charging cradle to charge the printer.

1 Remove the black protective seal labeled "CRADLE ACCESS" affixed to the bottom of the printer.

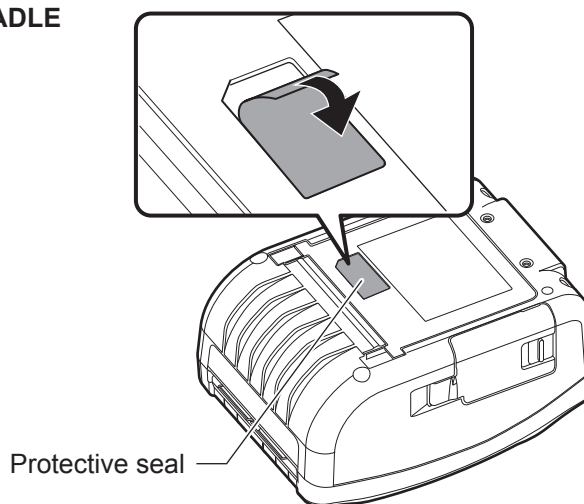

2 Connect the supplied AC adapter to the charging cradle.

Connect the DC plug to the charging cradle and the AC power plug to the AC outlet.

* The shape of power plug varies depending on the region.

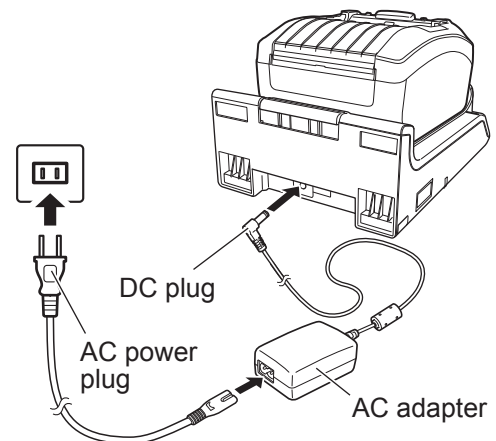

3 Connect the printer to the charging cradle.

Align the projections of the charging cradle with the indentations on the front of the printer (①), and then move the printer slowly downward and set it on the charging cradle (②).

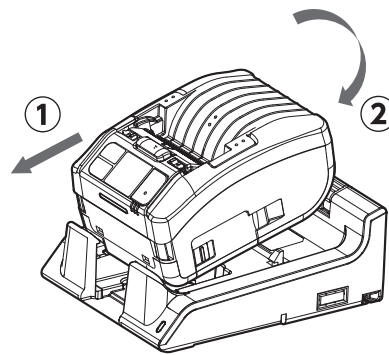

4 Charging starts.

For details on the display during charging, see “Icon” (☞ page 23).

Note

Notes when you use the printer being set on the charging cradle

- Set Full Charge P-Off (☞ page 89) to Disabled.
- Enabling the Eco Charge function (☞ page 88) is recommended to increase the life of the battery.
- When using the printer set on the charging cradle, you cannot power off the printer during charging. To power off the printer, set the time so that Auto Power-Off (☞ page 104) operates or remove the printer from the charging cradle.

Removing the printer from the charging cradle

Remove the printer while holding the Release button on the charging cradle pressed.

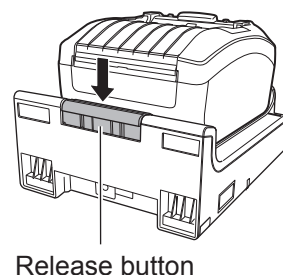

- Place the charging cradle in a location where it won't be exposed to water drops. If a terminal gets wet, it could cause a fire or electric shock.

Installing and using the charging cradle on a wall

You can set the printer on the charging cradle installed on a wall.

When installing the charging cradle on a wall, be sure to check the orientation so that the top and bottom sides of the cradle are set as illustrated orientation.

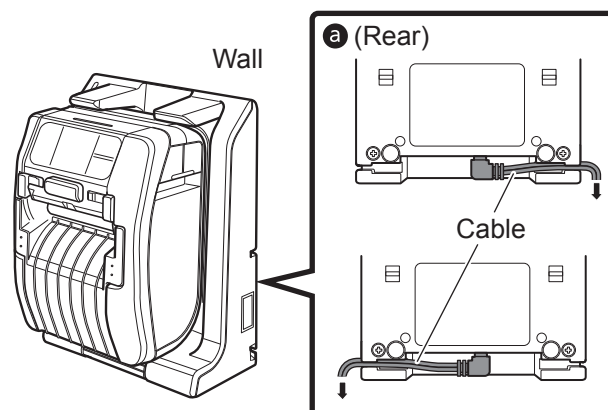

Note the following when you use the printer being set on the charging cradle mounted on a wall.

- When installing the charging cradle mounted on a wall, install it vertically on a flat wall that will not receive impact. If the charging cradle or the printer falls because of impact, it could cause an injury.
- Allow 150 mm or wider space around the charging cradle.
- To avoid injuries that may be caused by falling, attach or detach the printer with both hands.
- To prevent damage to the AC adapter, wire cables by routing them through the groove on the rear of the charging cradle before setting the printer on a wall **a**.

Note

- Prepare the screws for you to fasten the charging cradle to a wall.
- The screws to be used for fixing the charging cradle to the wall should have both shear strength and withdrawal strength to withstand loads of 15 Kgf (147 N) or more. You need 4 screws to install a 1Bay charging cradle, and 16 screws to install a 4Bay charging cradle (the diameter of a screw: 4.5 mm (0.2") or thicker).
- We assume no responsibility for any falling of the product that may be caused by insufficient installation strength or a customer's carelessness or inattention.

Notes on Charging

- If the  button is pressed during charging, the error below is displayed.
Error 1067 "CHARGING Wait till charging is complete."
- The power is automatically turned on when an AC adapter is connected to the printer.
- Do not remove the battery during charging. If the battery is removed during charging, the error below is displayed.
Error 1060 "NO BATTERY Please put battery."
- Even if Auto Power-Off is set to Enabled, the printer does not power off during charging.
- In the low-battery error status, printing and feeding operations cannot be performed during charging. Wait until the low-battery error is released.
- If a battery error occurs, do not use that battery. Replace it.
- If a "No battery" error occurs with the battery installed in the printer, replace the battery. To perform internal inspections, adjustments, and repairs, contact your SATO reseller or technical support center.
- If the printer is powered down during printing using a deteriorated battery and cannot be restarted, replace the battery.

1.2.4 Charging with Battery Charger (Optional)

Remove the battery from the printer and use the battery charger to charge it.
For details, refer to the operation manual supplied with the 1ch battery charger.

* The shape of power plug varies depending on the region.

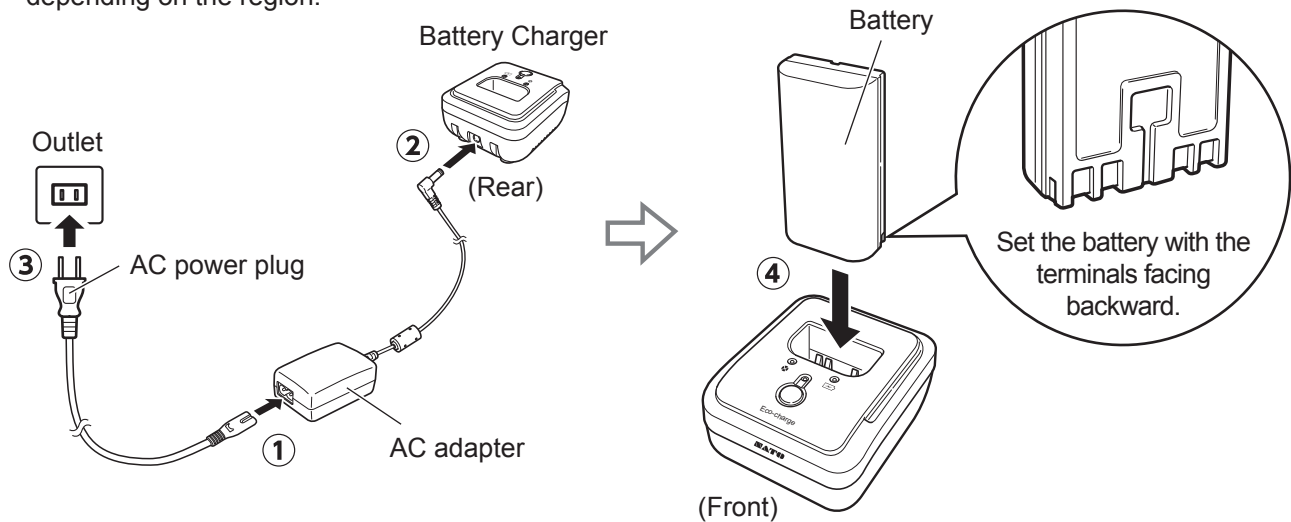

About Batteries

- The battery pack (the lithium ion battery pack) has a life expectancy. Even if the battery is fully charged, operation time gradually becomes shorter. It is the battery's characteristics, not an error or problem. We recommend that you replace the battery after approximately 300 charge cycles or 3 years from the date of first use, whichever is earlier.
- The charging time (about 3 hours) is for reference. It depends on temperature around the battery or its conditions.
- If you notice any dents or cracks on the battery pack crust caused by strong impacts or shocks, stop using the battery pack immediately and replace it with a new one. Continued use under these conditions may lead to abnormal overheating or fire.
- Charge the batteries in a place of 5 to 35°C (41 to 95 °F). Charging in high or low temperature may cause battery deterioration.
- If the printer is too hot or too cold, keep the battery in a place of 5 to 35°C (41 to 95 °F) for about 1 hour then charge the battery. Charging between 10 and 30°C (50 to 86°F) is recommended.
- When the battery temperature becomes higher or lower than the specified temperatures, the printer enters the standby mode for charging and stops charging.
- If the battery has not been charged for a long period of time, it may become unusable. Charge the battery regularly.
- Do not keep the battery fully charged. The battery may become deteriorated.
- Do not keep the battery in high temperature. The battery may become deteriorated.
- For how to use the battery charger, refer to the manual of the battery charger.

1.3 Loading the Media



- When loading the media, be careful not to get cut your finger with the cutter.

Use only the supply products specified by SATO.

Before use, check the printer operations with the media to be used.

1

Open the top cover.

Push the cover open button (①).

Open the top cover (②).

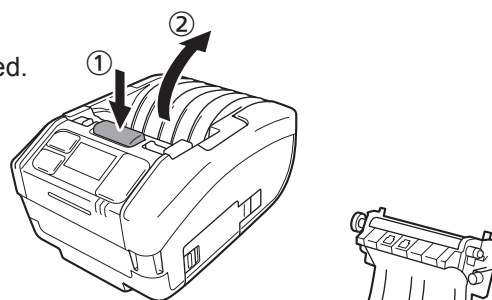

2

Adjust the media guide. (PW208NX only)

Push up the lever (①).

Adjust the media guide to the media size (②).

When you release the lever, the media guide is fixed.

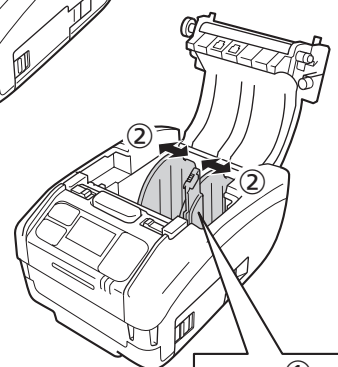

3

Load the media.

Load the media so that the surface touches the print head.

If the media is difficult to load, rewind the media roll so that the two ends of the roll become even.

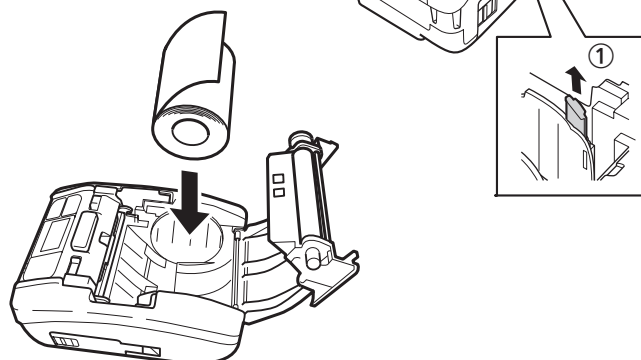

4

Close the top cover.

Close the cover so that it clicks shut.

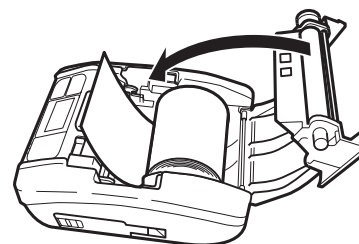

Note

Eject the media in the direction illustrated.

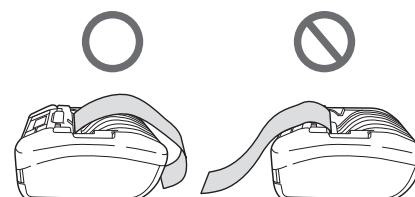

1.4 Display

The display has the following three modes.

- Normal mode
- Error message mode
- Settings mode

Displayed items differ depending on the mode.

1.4.1 Normal Mode

This display appears in normal mode.

- ① Shows the status icon.
- ② Shows the remaining battery level with an icon and a percentage (%).
- ③ Shows the message.
- ④ Shows the total count.
- ⑤ Shows the large icon.

For setting the large icon, see “Show Large Icon” of “2.6.5. System Menu” ([page 104](#)).

Normal mode



Large Icon display



1.4.2 Error Message Mode

This display appears in error message mode.

- ① Shows the error number.
- ② Shows the error icon.
- ③ Shows the type of the error.
- ④ Shows how to release the error status.

For details of display contents, see “3.1.1 Error Messages” ([page 130](#)).

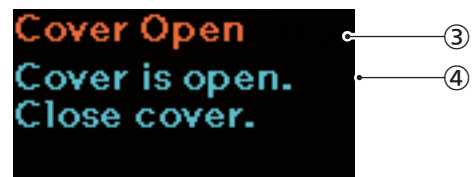

1.4.3 Settings Mode

This display appears in settings mode.

- ① Shows the type of setting menu.
- ② Shows the items to be set.
- ③ Shows the current setting value.

For details of display contents, see “2.4 Settings Modes” ([page 37](#)).



1.5 Icon

1.5.1 Status Icon

The icons on the display show the printer status.

The number of icons displayed is limited. Icons are displayed according to their priority, from the highest to the lowest.







Normal display



Large Icon display



- Printer Status

Status Icons	Description
	Printer is stopped. (offline)
	Printer is receiving data.
	Printer is printing. (online)
	Printer has paused printing. (offline)
	Printer is waiting for the printed media to be dispensed. This item is displayed only if the Dispenser mode (page 30) (PW208NX only) or Linerless in the Print mode (page 52) (page 51) is selected.
	The HEX-Dump mode is enabled. This item is displayed only if Enabled is selected in the HEX-Dump mode (page 114).

• Interface Information

Status Icons	Large icon	Description
	--	This item is displayed when the printer is connected to USB host.
		Bluetooth is enabled but not connected.
		Bluetooth is enabled and connected.
		Wi-Fi is enabled but not connected. This item is displayed only if the printer is wireless LAN model.
		Wi-Fi is connected. Signal Level: 1 This item is displayed only if the printer is wireless LAN model.
		Wi-Fi is connected. Signal Level: 2 This item is displayed only if the printer is wireless LAN model.
		Wi-Fi is connected. Signal Level: 3 This item is displayed only if the printer is wireless LAN model.
		Wi-Fi is connected. Signal Level: 4 This item is displayed only if the printer is wireless LAN model.
	--	This item is displayed when the Wi-Fi Direct is selected. This item is displayed only if the printer is wireless LAN model.
	--	This item is displayed when the USB memory is connected to the printer.
	--	NFC is enabled.
	--	NFC is disabled.







--: Large icon is not displayed.

• Battery Information

Eco Charge Disabled		Eco Charge Enabled		Description
Status Icons	Large icon	Status Icons	Large icon	
				<p>The displayed icon indicates the battery remaining level.</p> <p>When the Eco Charge function is disabled, the display content differs depending on the battery remaining level.</p> <p>The battery remaining level is also displayed in percentage (%) in the left of the icon.</p>
				<p>The printer is being charged with an AC adapter.</p> <p>When the Eco Charge function is disabled, the display content differs depending on the battery remaining level.</p> <p>The battery remaining level is also displayed in percentage (%) in the left of the icon.</p>
				<p>The battery cannot be charged since the temperature inside the printer is too high or low.</p>
				<p>When or appears, it is the time to replace the battery.</p>



For details on Eco Charge function, see “Eco Charge” in “2.6.3. Battery menu” ([page 88](#)).

- Warning Display

Icons	Description
	Receive buffer near full is detected. Available space for receive buffer is low. Wait until the icon disappears.
	A command error is detected. Indicates that the print data may be incorrect. Check the print data.
	Broken element of the print head is detected. Head error may be displayed depending on the print layout.
	IP address cannot be acquired. Perform Network connection and Network Settings again. When Network Settings are displayed properly, restart the printer.
	Authentication with iOS was interrupted. Wait for the icon to disappear (approximately 130 seconds), then perform Authentication with iOS again. During authentication with the iOS on process, do not power off the printer or remove the battery.
	Bluetooth connection with iOS cannot be established because of an error in the authentication chip. Contact your SATO reseller or technical support center.

For details on errors, see “3.3 List of Warning Icons” ([☞ page 138](#)).

- Notifications Display

Icons	Description
	Indicates the time to clean the printer. For setting cleaning interval, see “Notifications” of the “2.6.5 System Menu” (☞ page 99).
	Indicates the time to change the print head or platen roller. For setting changing interval, see “Notifications” of the “2.6.5 System Menu” (☞ page 99).









For details on notifications, see “3.4 Notifications” ([☞ page 139](#)).







For replacing the print head or platen roller, contact your SATO reseller or technical support center.

1.5.2 Error Icon

When a printer error occurs, the error status are displayed on the screen with an icon.



Icons	Description
	Printer error is detected.
	Program error is detected. Writing to the memory error is detected.
	The printer receives larger data than the buffer capacity (Receive buffer overflow). The printer received improper protocol.
	The cover is open.
	The media runs out.
	Media size error is detected.
	Print head error is detected.
	Command error is detected. CRC error is detected.
	The temperature of the print head, the printer, or the motor has exceeded the tolerance range.

Icons	Description
	Media sensor error is detected.
	Wi-Fi module error is detected.
	Bluetooth module error is detected.
	Charge the battery. The battery is being charged with low battery status.
	Battery deterioration is detected.
	Battery-related error (battery not inserted, battery deterioration, battery irregularities) is detected.
	The media has jammed.

For details on errors, see “3.2 Error List” ([↗ page 131](#)).

1.6 LED Lighting Pattern

The lighting patterns of the LEDs are described here.

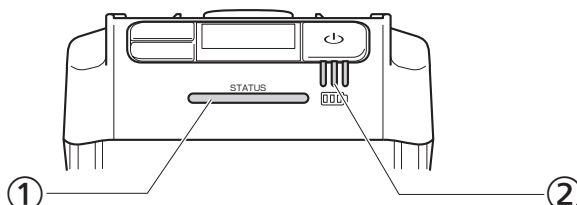

① Status LED indicator

Color: Blue/Red

Contents: Printer status

Offline: ○

Online: Blue ●

Energy Saving: Blue ◎ Long

Error message mode: Red ●

② Battery level LED indicator

Color: Green

Contents: Supplying power to the printer

Remaining battery level

- There are five lighting and flashing patterns of the LED.

Symbol	Lighting and flashing patterns	Interval of lighting and flashing
●	Lit	--
○	Unlit	--
◎	Flashing	400 ms lit, 400 ms unlit
◎ Short	Flashing with short interval	200 ms lit, 200 ms unlit
◎ Long	Flashing with long interval	100 ms lit, 1500 ms unlit

1.6.1 Normal Mode

Connection status of AC adapter/ Charging cradle	Battery condition	Status (STATUS)	Remaining battery level		
			1(Green)	2(Green)	3(Green)
Not connected	70% or more	–	●	●	●
	40% or more, less than 70%	–	●	●	○
	Less than 40%	–	⊙Short	○	○
	0% ^{*1}	Red●	○	○	○
	Not installed				
Connected	Charging is complete.	–	●	●	●
	70% or more	–	●	●	⊙
	40% or more, less than 70%	–	●	⊙	○
	Less than 40%	–	⊙	○	○
	0% ^{*2}	Red●	⊙	○	○
	Not installed ^{*3}	Red●	○	○	○

–: Differs depending on the printer status

*1: Error 1043 “Low battery” status

*2: Error 1059 “Charging” status

*3: Error 1060 “No battery” status

1.6.2 Energy Saving Mode

Printer does not go to the Energy Saving mode in low battery error.

Connection status of AC adapter/ Charging cradle	Battery condition	Status (STATUS)	Remaining battery level		
			1 (Green)	2 (Green)	3 (Green)
Not connected	70% or more	Blue ◎ Long	○	○	○
	40% or more, less than 70%	Blue ◎ Long	○	○	○
	Less than 40%	Blue ◎ Long	○	○	○
	0% ^{*1}				
	Not installed				
Connected	Charging is complete.	Blue ◎ Long	○	○	○
	70% or more	Blue ◎ Long	●	●	◎
	40% or more, less than 70%	Blue ◎ Long	●	◎	○
	Less than 40%	Blue ◎ Long	◎	○	○
	0% ^{*2}				
	Not installed ^{*3}				

*1: Error 1043 "Low battery" status

*2: Error 1059 "Charging" status

*3: Error 1060 "No battery" status

1.7 Dispenser Mode (PW208NX only)

1.7.1 Switching to the Dispenser Mode



- When setting up the dispenser unit, be careful not to get cut your finger with the cutter.

Use only the supply products specified by SATO.

Before use, check the printer operations with the media to be used.

1

Open the top cover.

Push the cover open button (①).
Open the top cover (②).

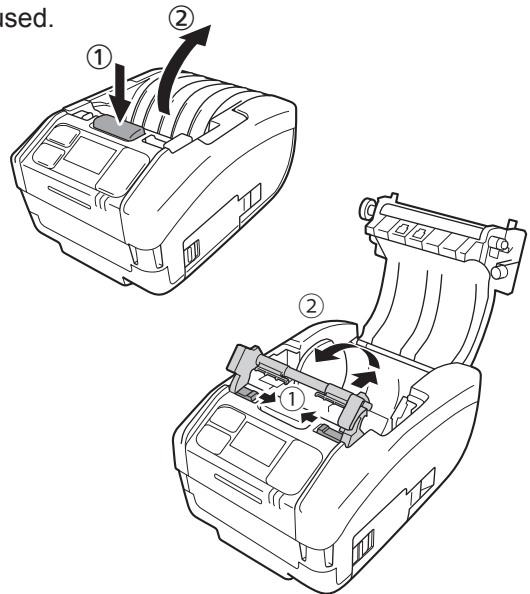

2

Set up the dispenser unit.

Slide the dispenser lever (①), and
set up the dispenser unit (②).

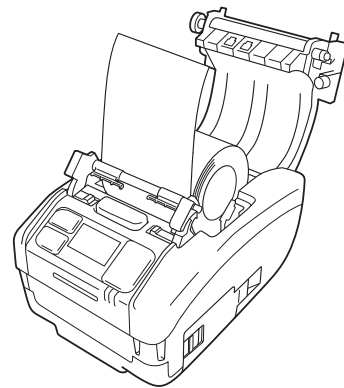

3

Load the media.

Pull out the media for one sheet, and then load
the media so that the surface touches the print
head.

If the media is difficult to load, rewind the media
roll so that the two ends of the roll become even.

4

Close the top cover.

Make sure the media fit between the dispenser
unit and top cover, and close the top cover so
that it clicks shut.

The print mode ([page 52](#)) automatically
switches to Dispenser mode after setting up the
dispenser unit.

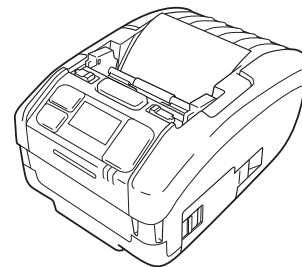

1.7.2 Switching Mode from the Dispenser Mode



- When setting up the dispenser unit, be careful not to get cut your finger with the cutter.

1**Open the top cover.**

Push the cover open button (①).

Open the top cover (②).

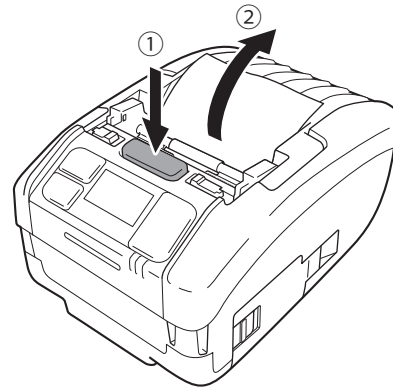
**2****Put back the dispenser unit in its original place.**

Push down the both sides of the dispenser unit so that they become even (①).

Slide the dispenser unit forward until it clicks (②).

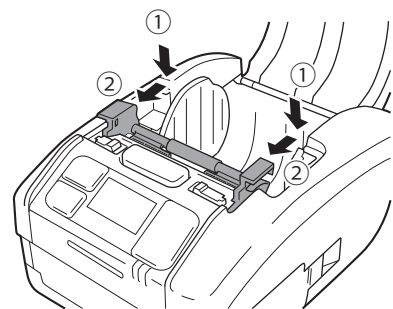

2

Starting Up the Printer

2.1 Printer Startup and Power Off

2.1.1 Printer Startup

- 1 Press the  button.

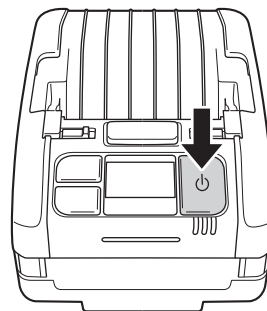



- 2 “Online” is displayed (only in normal display).

Normal display



Large Icon display



When Disabled is selected in Online Startup ([page 64](#)), “Offline” (only in normal display) and the  icon are displayed. Press the  button to switch to the print (online) screen.

Normal display



Large Icon display



2.1.2 Printer Power Off

- 1 Press the  button until the status LED indicator lights in red.

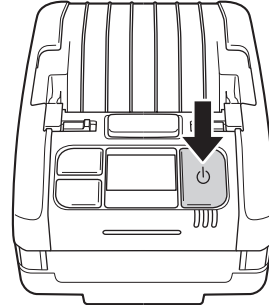

- 2 **“Do not remove battery” appears.**
Power-off is in progress. Wait until the red status LED indicator lights off with a beep, and display disappears.
Depending on the communication connection status, the time for displaying this screen may be longer.



2.2 Normal Mode

2.2.1 Online (Ready to Print) and Printing

Online (ready to print) screen

Screen for waiting for data reception.

Normal display



Large Icon display



Printing screen

Screen for printing the media.



 icon is displayed.

Normal display



Large Icon display



Button name and button pressing	Screen and printer operation
	When a print job exists in the printer: Changes to the pause (stop printing) screen. When no print job exists in the printer: Changes to the offline (stop) screen.
	In Online (ready to print) screen: When Reprint is set to Enabled, the printer starts reprinting data of the last job. For the Reprint setting, see “Reprint” of “2.6.1 Printing Menu” (page 66). In Printing screen: When Dispense Mode is set to Manual, the printer starts printing the new job. For the Dispenser Mode setting, see “Dispenser Mode” of “2.6.1 Printing Menu” (page 67).

2.2.2 Offline (Stop) and Pause (Stop Printing)

Offline (stop) screen

Screen when a print job stops.

 icon is displayed.

Press the  button to enable printing.

Normal display



Large Icon display



Pause (stop printing) screen

Screen when the printer temporarily stops printing.







 icon is displayed.

Normal display



Large Icon display



Button name and button pressing	Screen and printer operation
	Changes to the printing (online) screen.
	Feeds one sheet of media.
Press and hold the  and  buttons simultaneously for 2 seconds or longer.	No data exists: Changes to the settings mode screen. Data exist: Changes to the adjustment mode screen.
 + 	Data exist: Changes to the cancel print job screen.

2.2.3 Canceling Print Job

Cancel print job screen



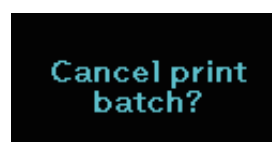

You can clear the received print data completely.

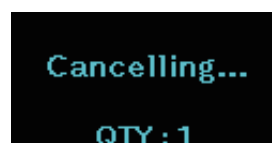

Screen during cancel print job

Screen while the received print data is being cleared.



Button name and button pressing	Screen and printer operation
	Changes to the offline (stop) screen without clearing print data.
	Clears the print data and changes to the offline (stop) screen.
 + 	Offline (stop) screen

2.3 Adjustment Mode

When you press and hold the button and button simultaneously for 2 seconds or more in the pause (stop printing) screen, the screen changes to the adjustment mode.

The adjustment mode has the following three submenus.

- Offset position adjustment
- Pitch position adjustment
- Print darkness adjustment

2.3.1 Screen Transition for Adjustment Mode

Button name and button pressing	Arrow direction	Screen and printer operation
		Moves to the next setting item.
		Selects the setting item, and moves to the setting screen.
+		Moves to the previous setting item.
button		While a submenu is displayed, moves to the offline (stop) screen. While a setting screen is displayed, cancels the input content and returns to the submenu.

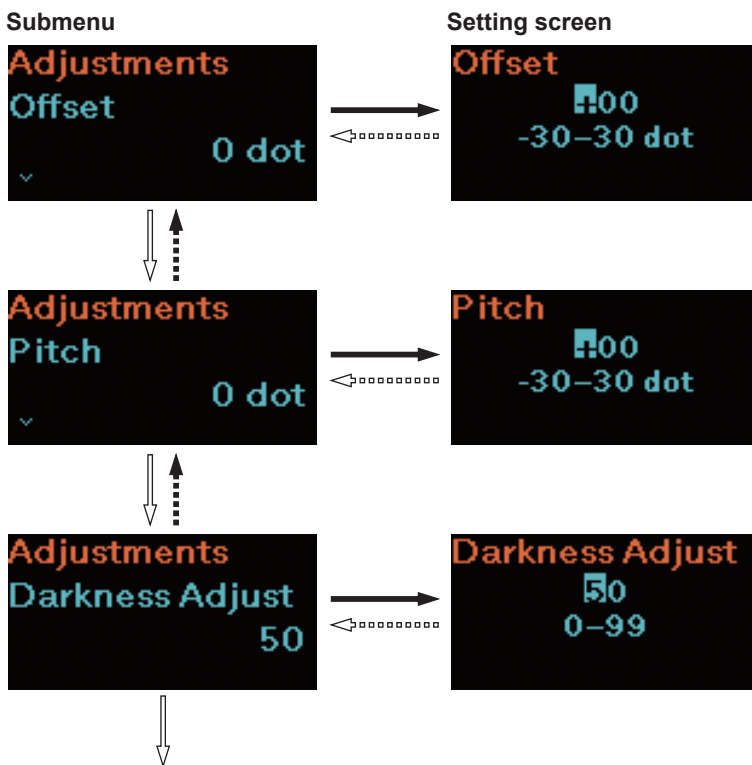

For details on each setting screen, see “Adjustments” of “2.6.1 Printing Menu” ([page 63](#)).

For detailed procedure to input values in the setting screen, see “2.4.4 Setting Screen (Value Input)” ([page 40](#)).

Return to the offset adjustments.

2.4 Settings Mode

The settings mode allows you to make various settings of the printer. The settings mode has the following main menus.



Main menu	Description
Wi-Fi Direct	Set up the Wi-Fi Direct function. This item is displayed only if the printer is wireless LAN model. For details on the settings mode screen, see “Wi-Fi Direct” of “2.6.2 Interface Menu” (☞ page 75).
Printing	Access the settings related to printing.
Interface	Access the settings related to the interfaces.
Battery	Access the settings related to the battery or the battery status.
Applications	Access the settings related to the printer command.
System	Access the settings related to the display language, buzzer volume etc.
Tools	Access the test print, initialization and other settings.
Information	Access the printer information.

2.4.1 Log In to the Settings Mode

- 1 **Display the offline (stop) screen.**
Press the ►||/→ button to display the offline (stop) screen.

- If there is the printing data, complete the print job before logging in to the settings mode.
- To cancel the print job, see “2.2.3 Canceling Print Job” (☞ page 35).



- 2 **Log in to the settings mode.**
When you press and hold the ►||/→ button and ⏪/← button simultaneously for 2 seconds or more in the offline (stop) screen, the screen changes to the settings mode screen.



2.4.2 Operations in Settings Mode Screens

Follow the buttons pressing instructions on the table below and the screen transition, select the setting screen from the settings mode screen. Main menus and submenus transit according to the menu tree structure. For details on the menu tree, see “2.5 Settings Mode Menu Tree” (page 42).

Button name and button pressing	Arrow direction	Screen and printer operation
▶ /→	→	Moves to the next setting item.
⏪/←	→	Selects the setting item, and moves to the next layer.
▶ /→ + ⏪/←	→	Moves to the previous setting item.
Press and hold ▶ /→ and ⏪/← buttons simultaneously for 2 seconds or longer.	→	Moves to the main menu.
⏻ button	→	While a main menu is displayed, moves to the offline (stop) screen. While a submenu is displayed, moves to the previous layer.

Screen Transition

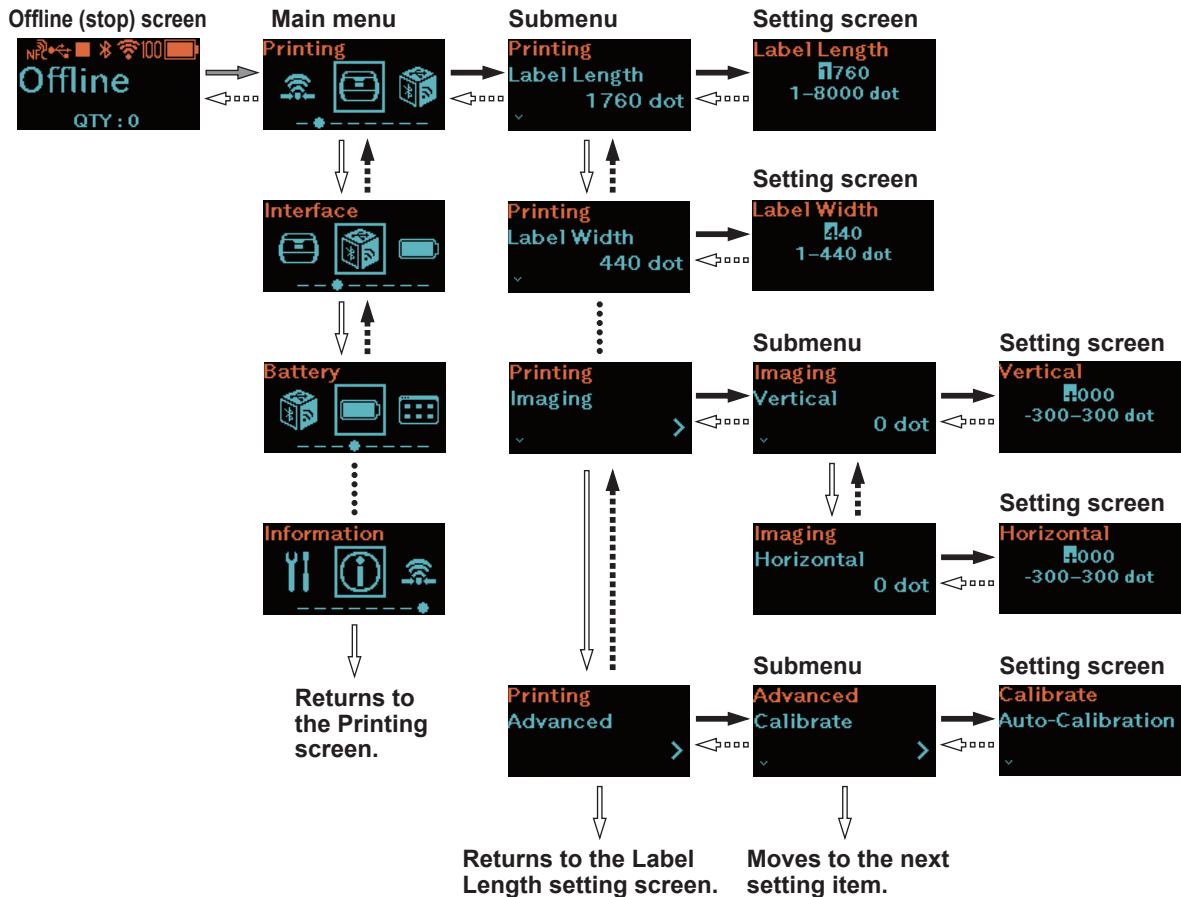

For detailed procedure to input values in the setting screen, see “2.4.4 Setting Screen (Value Input)” (page 40), and “2.4.5 Setting Screen (Setting Item)” (page 41).

2.4.3 Identifying the Submenus

A submenu screen contains the following information.

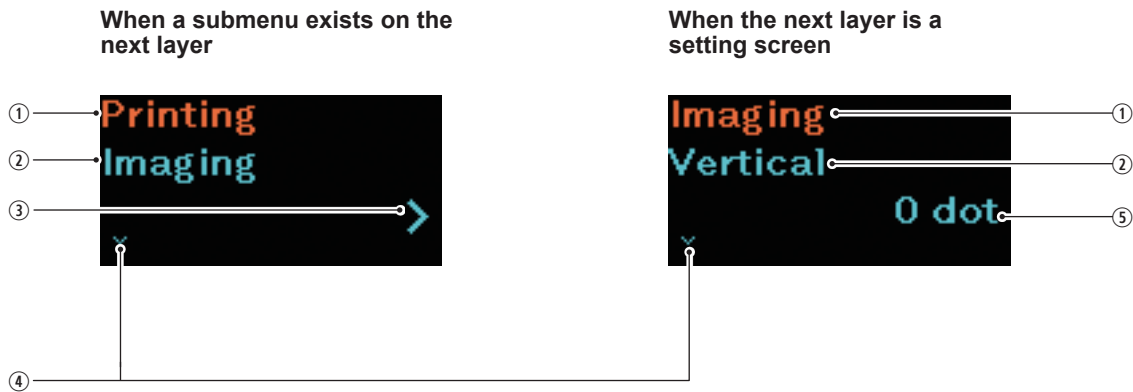

- | | |
|---|---|
| <p>① Setting items selected on the previous layer
Shows the setting item selected on the previous layer.</p> <p>② Setting items currently selected
Shows the submenu currently selected.</p> <p>③ > mark
This item is displayed when a submenu exists on the next layer.</p> | <p>④ V mark
This item is displayed when there is a next setting item.</p> <p>⑤ Current setting value
Shows the current setting value of the selected submenu.</p> |
|---|---|

2.4.4 Setting Screen (Value Input)

Follow the button pressing instructions on the table below and the screen transition, input a value.

Button name and button pressing	Arrow direction	Screen and printer operation
▶ /→	→	Sign: Toggles + and –. Value: Change the value by +1, or by 1 step. * ¹
⏏/←	→	Digit other than rightmost digit: Selects the sign and value and moves to a lower digit. Rightmost digit: Selects the input value and moves to the next submenu. * ²
▶ /→ + ⏏/←	→	Sign or the leftmost digit: Moves to the rightmost digit. Sign or digit other than leftmost digit: Moves to a sign or a upper digit.
⏏ button	→	Cancels the input content and returns to the submenu.

*1: When a value is outside the setting range ! mark flashes.

*2: When the submenu is the last submenu in an identical layer, returns to the submenu of the setting item.
While ! mark flashes, returns to the sign or the leftmost digit.

Identifying the Setting Screen





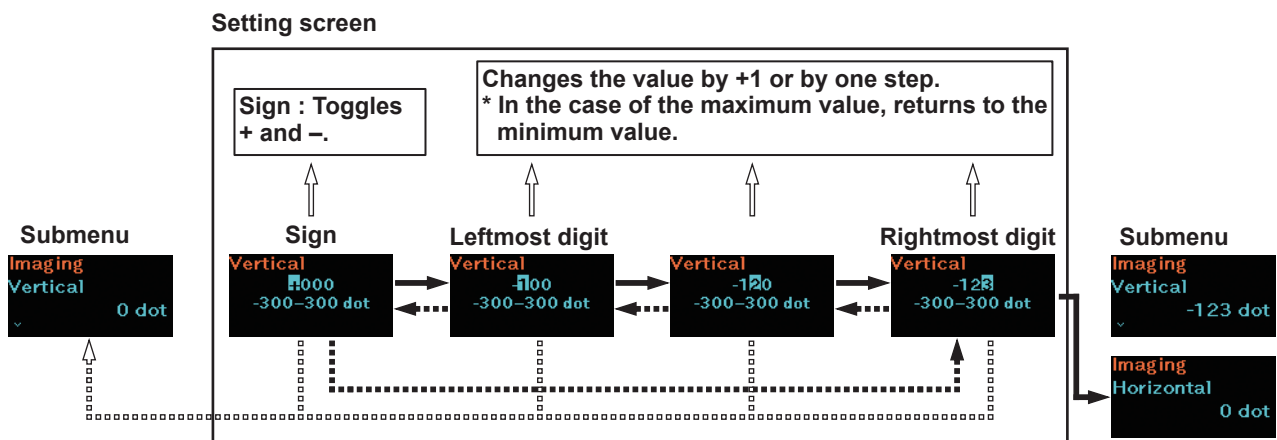

- ① Setting item currently selected
Shows the submenu currently selected.
- ② Input value
- ③ Setting range
- ④ ! mark
Flashes when the input value is outside the setting range.

Screen Transition



2.4.5 Setting Screen (Setting Item)

Follow the button pressing instructions on the table below and the screen transition, select a setting item.

Button name and button pressing	Arrow direction	Screen and printer operation
▶ /→		Moves to the next setting item.
⏏/←		Selects the setting item, and moves to the next submenu.*
▶ /→ + ⏏/←		Moves to the previous setting item.
⏏ button		Returns to the submenu.

*: When the submenu is the last submenu in an identical layer, returns to the submenu of the setting item.

Identifying the Setting Screen



- ① Setting item currently selected
Shows the submenu currently selected.
- ② Cursor
Shows the currently selected item.
- ③ V mark
This item is displayed when there is a next setting item.
- ④ Check mark
Shows the current setting item.

Screen Transition

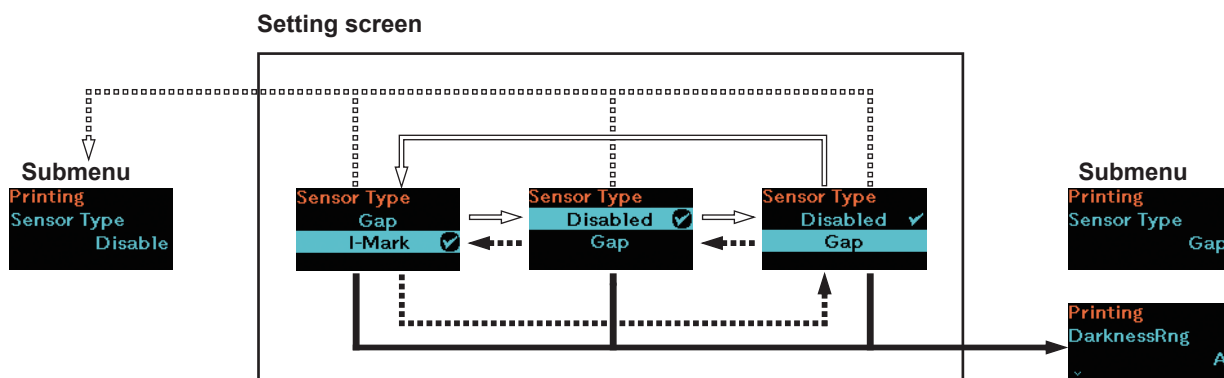



2.5 Settings Menu Tree Structure

There are 8 main menus in settings mode and each menu contains many layers of submenus. The tables below outline the settings menus tree structure for you to understand where information is located in the settings menus. Click on the items in blue to link directly to the details of the selected items.

 Wi-Fi Direct	Submenu
	Wi-Fi Direct

 Printing	Submenu				
	Label Length				
	Label Width				
	Auto Measure				
	Speed				
	Print Mode				
	Sensor Type				
	<table border="1"> <tr> <td>Peeling Setting (PW208NX only)</td> <td>Backfeed</td> </tr> <tr> <td></td> <td>Sensor Type</td> </tr> </table>	Peeling Setting (PW208NX only)	Backfeed		Sensor Type
	Peeling Setting (PW208NX only)	Backfeed			
		Sensor Type			
	DarknessRng (Darkness Range)				
	Darkness				
	<table border="1"> <tr> <td>Imaging</td> <td>Vertical</td> </tr> <tr> <td></td> <td>Horizontal</td> </tr> </table>	Imaging	Vertical		Horizontal
	Imaging	Vertical			
	Horizontal				

 Printing	Submenu		
Advanced	Calibrate	Auto-Calibration	
		Gap Sensor (PW208NX only)	Emission Level (PW208NX only)
			Receiving Level (PW208NX only)
			Slice Level (PW208NX only)
		I-Mark Sensor	Emission Level
			Receiving Level
	Slice Level		
	Head Check		
	Head Chk Mode		
	Every Page		
	Chk Media size		
	Adjustments	Offset	
		Pitch	
		Darkness Adjust	
	Start Online		
	Feed After Error		
	Feed At P-On		
	Finisher Feed		
	Paper End (PW208NX only)		
	Prioritize		
Reprint			
Print End Pos. (Print End Position)			
Dispenser Mode			

	Interface	Submenu			
Network (PW208NX only: Wireless LAN model)	Settings	Wi-Fi (Wireless LAN model)	IPv4	Mode	
				DHCP	
				IP Address	
				Netmask	
				Gateway	
				DNS	
			IPv6	Mode	
				DHCP	
				IP Address	
				Prefix Length	
				Gateway	
				DNS	
			Proxy	Enabled	
				Server	
				Exclude	
			WPS	Button (PBC)	
				PIN	
			Wi-Fi Direct	Name	
				Connect	
				Start Group	
				Button (PBC)	
				Disconnect	
				Remove Group	
				SSID	
				IP Address	
				Passphrase	
				SSID	
			Hidden SSID	Mode	
				Channel	
			Security	WEP Conf.	Authentication
					Key Index
WPA Conf.	WPA Authentication				
	EAP Conf.				
EAP Conf.	EAP Mode				
	Inner Method				
	Inner Method				
	Inner Method				
	Username				
	Anon.Outer ID				
	Verify Server Cert.				
PAC Auto Provisioning					

	Interface		
	Submenu		
Network (PW208NX only: Wireless LAN model)	Services	Ports	Port1
			Port2
			Port3
			Flow Control
	Advanced	LPD	Enabled
		DNS Lookup	
		FTP	Enabled
	Advanced	ARP Announce	Additional
			Periodic
	USB	Flow Control	
Bluetooth	Enable		
	Name		
	Pin Code		
	BD Address		
	Firm Version		
	Host BD Addr		
	IAP Ready		
	iOS Reconnect		
	Authentication		
	ISI		
	ISW		
	PSI		
	PSW		
	Give BD Address		
	IO Compatible		
CRC Mode			
Flow Control			
NFC	I/F Enable		
Ignore CR/LF			
Ignore CAN/DLE			

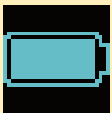
	Battery		
	Submenu		
	Health		
	Cycle Counts		
	Eco Charge		
	Full Charge P-Off		

Applications		Submenu	
Protocol			
SBPL	Show Error		
	Standard Code		
	Orientation		
	Font Settings	Zero Slash	
		Kanji	Kanji Set
			Character Code
			Kanji Style
		Proportional	
		Code Page	
		€	
	Compatible	CODE128(C)	
		Call Font/Log	
		QTY Timing	
		Character Pitch	
SZPL	Label	Shift	
		Top	
	Caret		
	Delimiter		
	Tilde		
	Clock Format		
	Default Font		

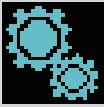
	System	Submenu	
	Regional	Messages	
		Unit	
	Notifications	Clean Head	Clean Head Head Interval Clean Counter
		Change Head	Change Head Head Interval Head Counter
		Change Platen	Change Platen Platen Interval Platen Counter
	Sound	Error Sound	
	Energy Saving	Sleep Timeout	
		Auto Power-Off	
	Show Total Cnt		
	Show Large Icons		
	Password	Password Enable	
		Install Security	
		NFC Security	
		Change Pwd	admin manager level1

Tools		Submenu	
Test Print	BD Address	Print	
		Pitch	
		Offset	
		Darkness Adjust	
	Factory	Print	
		Pitch	
		Offset	
		Darkness Adjust	
	Configure List	Print	
		Label Length	
		Pitch	
		Offset	
		Darkness Adjust	
	Configure QR	Print	
		Label Length	
		Pitch	
		Offset	
		Darkness Adjust	
	Paper Sensor	Print	
		Label Length	
Pitch			
Offset			
Darkness Adjust			
HEX-Dump	Hex Dump Mode		
	Buffer Dump		
	Log Files	Remove	
Reset	Select	Print	
		Data	
		Data & Settings	
Service			
Factory			
Wi-Fi Site Survey (PW208NX only : Wireless LAN model)	SiteSurveyDisp.		
	SiteSurveyPrint		

	Information Submenu	
Build Version	Version	
	Date	
	Checksum	
	Kernel Version	
Boot Version	Disks	
	Warp!!-mode	
	Date	
Applications		
Installation Log (Not visible without log data)		
Print Module	Main	Name
		Date
Sensor Module	Boot	Name
		Date
		Checksum
	Main	Version
		Date
		Checksum
Counters	Head	Life
		Head 1
		Head 2
		Head 3
Active printing	Print Mode	
	Sensor Type	
IPv4 address (Wireless LAN model)		
IPv6 address (Wireless LAN model)		
Wi-Fi MAC (Wireless LAN model)		
Wi-Fi Region (Wireless LAN model)		
Wi-Fi Status (Wireless LAN model)		
Wi-Fi Direct (Wireless LAN model & Wi-Fi Direct connection)	SSID	
	Role	
	Device Address	
	IP Address	
	Passphrase	
Wi-Fi Version (Wireless LAN model)		

2.6 Details of the Settings Menu Screen

2.6.1 Printing Menu

In the Printing menu, the setting items are as follows:

Printing			
1	Label Length	Set the length of media.	
2	Label Width	Set the width of media.	
3	Auto Measure	When enabled, the length of media is measured automatically.	
4	Speed	Set the maximum print speed.	
5	Print Mode	Set the print mode.	
6	Sensor Type	Set the media sensor type.	
7	Peeling Setting (PW208NX only)	Set the peeling motion in the Dispenser mode.	
8	DarknessRng	Set the range of the print darkness.	
9	Darkness	Set the print darkness.	
10	Imaging	Set the print reference position in the vertical and horizontal directions.	
11	Advanced	Set the sensor operation and print motion.	
<p><input type="checkbox"/> Note</p> <p>The printer uses the unit of dot to set the length and size of print reference position. One dot length is 0.125 mm.</p>			

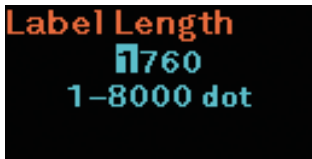
Label Length	
Printing > Label Length Set the length of media. Initial value : 1760 dots Setting range : 1 to 8000 dots <hr/> <input type="checkbox"/> Note Set the label size to a value that includes the liner.	

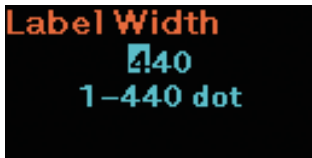
Label Width	
Printing > Label Width Set the width of media. Initial value : 440 dots Setting range : 1 to 440 dots <hr/> <input type="checkbox"/> Note Set the label size to a value that includes the liner.	

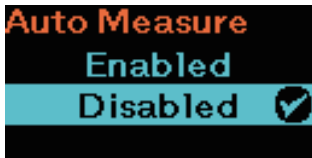
Auto Measure	
<p>Printing > Auto Measure</p> <p>The printer automatically measures the length of the media. The measured length of the media will be automatically saved in Label Length. The Auto Measure function is available when Sensor Type is set to Gap or I-Mark.</p> <p>Initial value: Disabled Setting options: Enabled, Disabled</p> <p>The setting procedure of the level length using the Auto Measure function is as follows:</p> <ol style="list-style-type: none"> 1. Load the media. 2. Set Auto Measure to Enabled. 3. Press the /← button or /→ button to display the Online or Offline screen. 4. Open the print head. (Head Open error occurs.) 5. Close the print head. (The display returns to Offline screen.) 6. Press the /← button so that the printer feeds two sheets of label and measures the label length. 7. The measured label length is saved in Label Length. <hr/> <p> Note When you have set Auto Measure to Enabled, this function is executed when the printer is powered on.</p>	

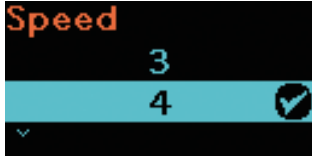
Speed	
<p>Printing > Speed</p> <p>Set the maximum print speed.</p> <p>Initial value : 4 ips (inches/sec) Setting range : 3, 4 ips (inches/sec) (If Linerless) : 3 to 6 ips (inches/sec) (If Tear-off, or Continuous)</p> <p>3: 75 mm/sec (3 inches/sec) 4: 101 mm/sec (4 inches/sec) 5: 127 mm/sec (5 inches/sec) 6: 152 mm/sec (6 inches/sec)</p> <hr/> <p> Notes</p> <ul style="list-style-type: none"> • Fast print speed may affect the print quality. • The actual print speed may vary depending on the battery capacity, environment, or print layout. • If the print mode is set to Dispenser mode (page 30), the print speed is limited to the maximum 4 ips (inches/sec). (PW208NX only) 	

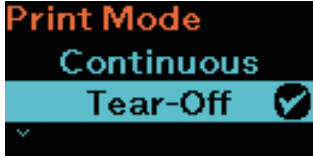
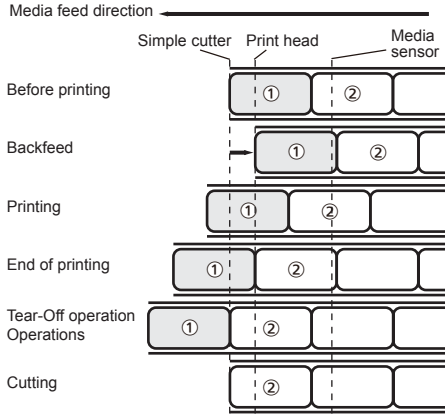
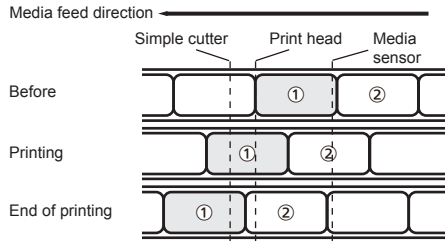
Print Mode	
Printing > Print Mode	
Set the print mode.	
Initial setting : Tear-Off	
Setting options : Tear-Off, Linerless, Continuous	
<p>Tear-Off : After printing the specified number of sheets continuously, the media roll is fed to the cutter position automatically. In this mode, the media roll is easily cut manually after printing. For the next printing, the media roll is fed back to the print head and printing starts.</p>	
	
<p>Linerless : Cut each sheet of media after printing the specified number of sheets continuously.</p>	
<p>Continuous : The specified number of sheets are continuously printed. After printing the specified number of sheets or printing a single sheet, the next print start position is placed at the print head.</p>	
	
<p> Note When the dispenser unit is set ready for dispenser print (page 30), the print mode automatically switches to the Dispenser mode. (PW208NX only)</p>	
<p>Dispenser : The liner is peeled from the printed sheet of media. Once the printed sheet has been removed, the next sheet of media is set at the position for printing.</p>	



Sensor Type	
Printing > Sensor Type Set the type of media pitch sensor to be used. Initial setting : I-Mark Setting options : None, I-Mark, Gap (PW208NX only: In Tear-Off or Continuous print mode) I-Mark : Use the reflective type sensor to detect the reference position (I-mark) on the media. Gap: Use the transmissive type sensor to detect the reference position (gap) on the media. None: Disable the media pitch sensor.	

Peeling Setting (PW208NX only)		
Printing > Peeling Setting To make settings for peeling motion, following setting items are available.		
1	Backfeed	Set the backfeed motion in the Dispenser mode.
2	Sensor Type	Set the type of media pitch sensor to be used in the Dispenser mode.

Backfeed (PW208NX only)	
Printing > Peeling Setting > Backfeed Set the backfeed motion in the Dispenser mode. Initial setting : Before Setting options : None, Before, After None : The printer does not backfeed after printing and dispensing the media. Before : Before printing, the printer performs backfeed motion to align the front part of media with the print head position. After : The printer performs backfeed motion to align the front part of the next media with the print head position after printing and dispensing the media.	

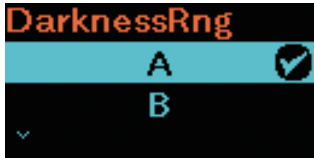
Sensor Type (PW208NX only)	
Printing > Peeling Setting > Sensor Type Set the type of media pitch sensor to be used in the Dispenser mode. Initial setting : I-Mark Setting options : Gap, I-Mark I-Mark : Use the reflective type sensor to detect the reference position (I-mark) on the media. Gap : Use the transmissive type sensor to detect the reference position (gap) on the media.	

DarknessRng (Darkness Range)	
<p>Printing > DarknessRng</p> <p>Set the darkness of the characters and graphics.</p> <p>Initial setting : A</p> <p>Setting options : A, B, C, D, E, F</p> <hr/> <p> Note</p> <p>The normal setting is A. You can also select B to F but the print darkness does not change.</p> <hr/>	

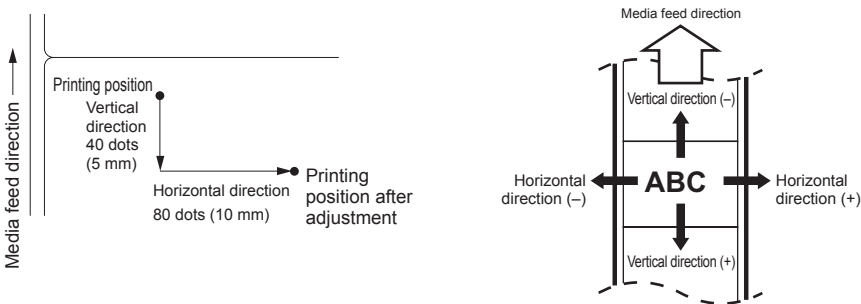
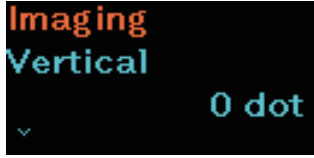

Darkness	
<p>Printing > Darkness</p> <p>Set the darkness of the characters and graphics.</p> <p>Initial value : 5</p> <p>Setting options : 1 to 10</p> <hr/> <p> Note</p> <p>1 is the lightest and 10 is the darkest.</p> <hr/>	

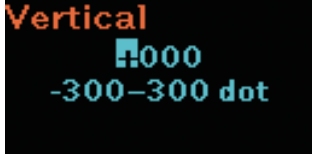
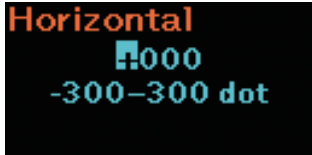

Imaging		
<p>Printing > Imaging</p> <p>To set print reference position in the vertical and horizontal directions, the setting items are as follows:</p>		
1	Vertical	Offset the print position in the vertical (feed) direction.
2	Horizontal	Offset the print position in the horizontal direction.
		

Vertical	
<p>Printing > Imaging > Vertical</p> <p>Set the print position by setting how many dots are apart from the print reference point vertically. + and – indicate the directions to shift.</p> <p>Initial value : 0 dot Setting range : –300 to 300 dots</p>	
Horizontal	
<p>Printing > Imaging > Horizontal</p> <p>Set the print position by setting how many dots are apart from the print reference point horizontally. + and – indicate the directions to shift.</p> <p>Initial value : 0 dot Setting range : –300 to 300 dots</p>	

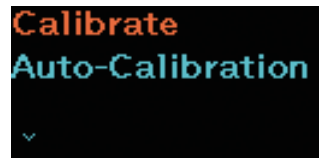
Advanced		
Printing > Advanced		
To set detailed sensor operation and print motion, the setting items are as follows:		
1	Calibrate	Set the media sensor adjustments.
2	Head Check	Set the head check operation.
3	Head Chk Mode	Set the head check method. This item is displayed only if Head Check is set to All or Barcode.
4	Every Page	Set the interval to perform head check by specifying the number of media. This item is displayed only if Head Chk Mode is set to Every Page.
5	Chk Media size	Enable or disable media size check. This item is displayed only if Sensor Type is set to Gap or I-Mark.
6	Adjustments	Adjust the offset, print position and print darkness.
7	Start Online	Set the status when the printer starts.
8	Feed After Error	Set whether the media roll is to be fed by one sheet and switches automatically to the printing (online) screen when the printer recovers from an error.
9	Feed At P-On	Set whether the media roll is to be fed by one sheet when the printer starts.
10	Finisher Feed	Set the length to feed after printing in the tear-off or Dispenser mode.
11	Paper End (PW208NX only)	Select the sensor for detecting the paper end.
12	Prioritize	Set which takes priority, printer setting or command setting.
13	Reprint	Enable or disable the reprint function.
14	Print End Pos. (Print End Position)	Set the print end position of media.
15	Dispenser Mode	Set the dispenser motion.

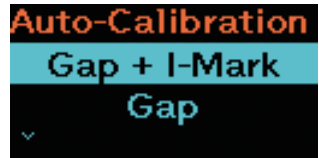

Calibrate			
Printing > Advanced > Calibrate Adjust the media sensor level. When there is malfunction of media detection, adjust the media sensor level (Gap and I-mark sensor). To adjust the media sensor, set the following items.			
1	Auto-Calibration	Adjust the sensor level automatically.	
2	Gap Sensor	Adjust the Gap sensor level manually.	
3	I-Mark Sensor	Adjust the I-Mark sensor level manually.	
<hr/> <div style="border: 1px solid black; padding: 5px;"> <p> Note</p> <p>If the media does not feed correctly after executing Auto-Calibration, contact your SATO reseller or technical support center.</p> </div> <hr/>			

Auto-Calibration		
Printing > Advanced > Calibrate > Auto-Calibration Perform auto-calibration for the selected media sensor. Initial setting : Gap + I-Mark (PW208NX) / I-Mark (PW208mNX) Setting options: Gap + I-Mark , Gap, I-Mark (PW208NX) / I-Mark (PW208mNX) Gap + I-Mark : Adjust both Gap sensor and I-Mark sensor automatically. Gap : Adjust the Gap sensor level automatically. I-Mark : Adjust the I-Mark sensor level automatically.		For PW208NX:  For PW208mNX: 
<hr/> <div style="border: 1px solid black; padding: 5px;"> <p> Notes</p> <ul style="list-style-type: none"> • When using a PW208mNX, the Auto-Calibration is set to I-Mark. You cannot change the setting. • Before making an adjustment, set the specified media on the sensor and close the cover. If you are using labels, remove the label from the liner. Align it so that the media sensor does not detect the I-Mark (black mark). </div> <hr/>		

Gap Sensor (PW208NX only)							
<p>Printing > Advanced > Calibrate > Gap Sensor</p> <p>Adjust the Gap sensor level manually.</p> <p>The adjustment reference values are as follows:</p> <p>Low : 0.5 V or less High-Low : 1.0 V or more</p> <p>The Gap sensor has the following setting items:</p> <table border="1"> <tr> <td>1</td> <td>Emission Level</td> </tr> <tr> <td>2</td> <td>Receiving Level</td> </tr> <tr> <td>3</td> <td>Slice Level</td> </tr> </table> <p>■ Manual Adjustment of the Gap Sensor</p> <ol style="list-style-type: none"> 1. Remove the label, and then set the liner. Align the liner so that the media sensor does not detect the I-Mark (black mark). 2. Close the cover. 3. Select Calibrate > Gap Sensor > Emission Level. 4. Press the ▶ /→ button to change the Emit value so that the Sensor value is adjusted to 0.5 or lower. 5. Press the ↵/← button to decide the value. 6. Select Calibrate > Gap Sensor > Receiving Level. 7. Press the ▶ /→ button to change the Recv value so that the Sensor value is adjusted to meet the following: Sensor High value - Sensor Low value ≥ 1.0 V Sensor High value: Label + Liner parts Sensor Low value: Gap part Adjust the values so that the Sensor value in the Liner part is approximately 0.2 V to 0.3 V. Then, pull the media to check that the Label + Liner parts value - the Gap part value ≥ 1.0 V. 8. Press the ↵/← button to decide the value. 		1	Emission Level	2	Receiving Level	3	Slice Level
1	Emission Level						
2	Receiving Level						
3	Slice Level						
							

Emission Level (PW208NX only)	
<p>Printing > Advanced > Calibrate > Gap Sensor > Emission Level</p> <p>Adjust the Gap sensor emission level.</p> <p>Emit : Initial value : 3 : Setting range : 0 to 7</p>	
	

Receiving Level (PW208NX only)	
Printing > Advanced > Calibrate > Gap Sensor > Receiving Level Adjust the Gap sensor receiving level. Receive : Initial value : 62 : Setting range : 0 to 127	

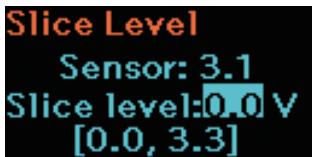
Slice Level (PW208NX only)	
Printing > Advanced > Calibrate > Gap Sensor > Slice Level Adjust the Gap sensor slice level. Slice level : Initial setting : 0.0 V(Auto) : Setting options : 0.0 V to 3.3 V ■ Slice Level Adjustment of the Gap Sensor 1. Use the following formula to calculate the slice level. (High value – Low value) ×0.7 + Low value = Slice Level 2. Select Calibrate > Gap Sensor > Slice Level. 3. Press the ► /→ button to change the slice level. Adjust the slice level so that it becomes the level calculated in step 1. 4. Press the ⏪/◀ button to decide the slice level.	

I-Mark Sensor	
Printing > Advanced > Calibrate > I-Mark Sensor Adjust the I-Mark sensor level manually. The adjustment reference values are as follows: Low : 0.5 V or less High-Low : 1.0 V or more The I-Mark sensor has the following setting items:	
1	Emission Level
2	Receiving Level
3	Slice Level
<p>■ Manual Adjustment of I-Mark Sensor</p> <ol style="list-style-type: none"> Remove the label, and then set the liner. Align the liner so that the media sensor does not detect the I-Mark (black mark). Close the cover. Select Calibrate > I-Mark Sensor > Emission Level. Press the ▶ /→ button to change the Emit value so that the Sensor value is adjusted to 0.5 or lower. Press the ↕/← button to decide the value. Select Calibrate > I-Mark Sensor > Receiving Level. Press the ▶ /→ button to change the Recv value so that the Sensor value is adjusted to meet the following: Sensor High value - Sensor Low value ≥ 1.0 V Sensor High value: I-Mark part Sensor Low value: Liner part Adjust the values so that the Sensor value in the Liner part is approximately 0.3 V to 0.5 V. Then, pull the media to check that the I-Mark part value - the Label + Liner parts value ≥ 1.0 V. Press the ↕/← button to decide the value. 	





Emission Level	
Printing > Advanced > Calibrate > I-Mark Sensor > Emission Level Adjust the I-Mark sensor emission level. Emit : Initial value : 1 : Setting range : 0 to 3	

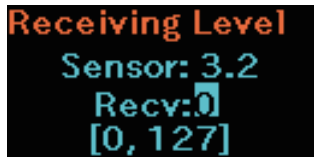

Receiving Level	
Printing > Advanced > Calibrate > I-Mark Sensor > Receiving Level Adjust the I-Mark sensor receiving level. Receive : Initial value : 57 : Setting range : 0 to 127	

Slice Level	
Printing > Advanced > Calibrate > I-Mark Sensor > Slice Level Adjust the I-Mark sensor slice level. Slice level : Initial setting : 0.0 V(Auto) : Setting range : 0.0 V to 3.3 V ■ Slice Level Adjustment of the I-Mark Sensor 1. Use the following formula to calculate the slice level. (High value – Low value) ×0.7 + Low value = Slice Level 2. Select Calibrate > I-Mark Sensor > Slice Level. 3. Press the ► /→ button to change the slice level. Adjust the slice level so that it becomes the level calculated in step 1. 4. Press the ⬅/⬅ button to decide the slice level.	

Head Check	
Printing > Advanced > Head Check Set the head check operation. Initial setting : All Setting options : Off, All, Barcode Off : Head Check disabled. All : Check the entire print area. Barcode : Check only the area for a printed barcode. Head check is not applicable for barcodes printed as graphic data. About Head Check Function Head check is the function to check broken element of the print head automatically. If an error occurs, printing stops. Head check is a reference for checking broken element of the print head. This function does not guarantee barcode readability. Check barcode readability regularly. (Failure to print does not necessarily correspond to functioning of the head check.) Check the label printed after head error is generated by scanning the printed barcode.	

Head Chk Mode	
<p>Printing > Advanced > Head Chk Mode</p> <p>Set the head check timing in the head check mode. This item is displayed only if Head Check is set to All or Barcode.</p> <p>Initial setting : Always Setting options : Always, After Batch, Every Page</p> <p>Always : Perform the head check for every item. After Batch : Perform the head check when the printer starts and ends printing. If backfeed is applicable, the printer performs the head check at the beginning and end of printing and during the backfeed. Every Page : Perform the head check for each specified number of media.</p>	

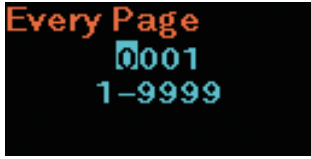
Every Page	
<p>Printing > Advanced > Every Page</p> <p>Set the interval to perform head check by specifying the number of media. This item is displayed only if Head Chk Mode is set to Every Page.</p> <p>Initial value : 1 Setting range : 1 to 9999</p>	

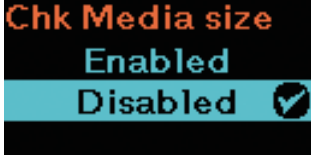
Chk Media size	
<p>Printing > Advanced > Chk Media size</p> <p>Enable or disable media size check. The Media size check function detects a media longer than the media size specified by command, or the print data larger than the loaded media length. This item is displayed only if Sensor Type is set to Gap or I-Mark.</p> <p>Initial setting : Disabled Setting options : Enabled, Disabled</p> <p>Enabled: Enable the Chk Media size function. Disabled: Disable the Chk Media size function.</p>	

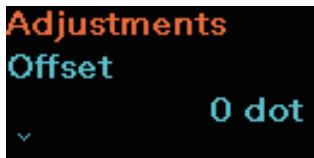
Adjustments		
Printing > Advanced > Adjustments		
To set the adjustments mode, set the following items.		
1	Offset	Set the offset position.
2	Pitch	Set the print position.
3	Darkness Adjust	Fine tune the print darkness of the print.
<p> Note</p> <p>The values for Offset and Pitch specified in the Adjustments are reflected in the relevant setting items in Test Print (pages 108 to 113).</p>		
		

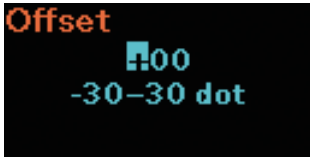
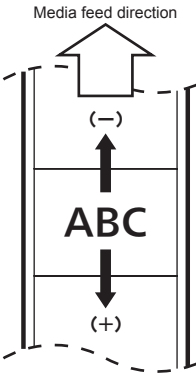
Offset	
Printing > Advanced > Adjustments > Offset	
<p>Adjust the stop position.</p> <p>The stop position refers to the tear-off position, cut position and dispenser stop position.</p> <p>Set an offset value + to move the print position opposite the feed direction and value – to move the print position in the feed direction.</p> <p>Initial value : 0 dot</p> <p>Setting range : –30 to 30 dots</p>	
	

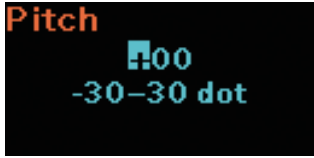
Pitch	
Printing > Advanced > Adjustments > Pitch	
<p>Move the print position in the vertical direction.</p> <p>Set an offset value + to move the print position opposite the feed direction and value – to move the print position in the feed direction.</p> <p>Initial value : 0 dot</p> <p>Setting range : –30 to 30 dots</p>	

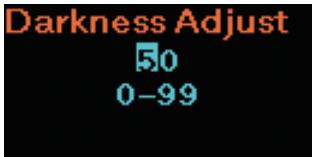
Darkness Adjust	
<p>Printing > Advanced > Adjustments > Darkness Adjust</p> <p>Fine tune the print darkness.</p> <p>Initial value : 50 Setting range : 0 to 99</p> <hr/> <p> Notes</p> <ul style="list-style-type: none"> • 0 is the lightest and 99 is the darkest. • Refer to “Darkness” (page 54). 	

Start Online	
<p>Printing > Advanced > Start Online</p> <p>Set the status when the printer starts.</p> <p>Initial setting : Enabled Setting options : Enabled, Disabled</p> <p>Enabled: The printing (online) screen is displayed when the printer is powered on. Disabled: The offline (stop) screen is displayed when the printer is powered on.</p>	

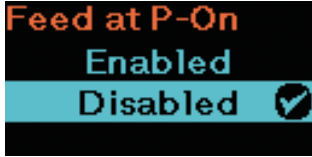

Feed After Error	
<p>Printing > Advanced > Feed After Error</p> <p>Set whether the printer feeds one sheet of the media roll and switches to the printing (online) screen automatically after it recovers from an error.</p> <p>Initial setting : Disabled Setting options : Enabled, Disabled</p> <p>Enabled: The printer feeds the media by one sheet after recovering from an error and changes to the printing (online) screen. Disabled: The offline (stop) screen is displayed after the printer recovers from an error. Even if you manually switch to the printing (online) screen, the printer does not feed the media by one sheet.</p>	

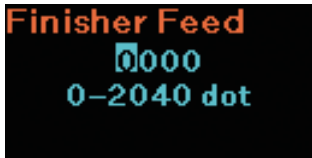
Feed At P-On	
Printing > Advanced > Feed At P-On Set whether the media roll is to be fed by one sheet when the printer is powered on. Initial setting : Disabled Setting options : Enabled, Disabled Enabled: The printer feeds the media when it is powered on and switches to the printing (online) screen. Disabled: The printer does not feed the media when it is powered on and switches to the offline (stop) screen.	

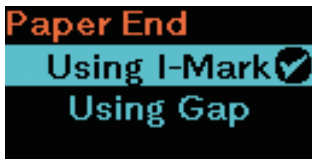

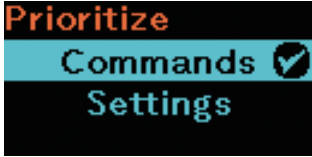

Finisher Feed																
Printing > Advanced > Finisher Feed Set the media feed amount based on the print head position. Initial setting : 0 dot Setting range : 0 to 2040 dots Other than 0 : The printer operates with the specified media feed amount. 0 : The printer operates with the fixed value contained in the printer. When the 0 is set, the amount for each mode are as follows. <table border="0" style="margin-left: 40px;"> <tr> <td>PW208NX :</td> <td>Tear-Off</td> <td>: 88 dots</td> </tr> <tr> <td></td> <td>Linerless</td> <td>: 64 dots</td> </tr> <tr> <td></td> <td>Dispenser</td> <td>: 0 dot</td> </tr> <tr> <td>PW208mNX:</td> <td>Tear-Off</td> <td>: 66 dots</td> </tr> <tr> <td></td> <td>Linerless</td> <td>: 30 dots</td> </tr> </table> About Finisher Feed amount Finisher Feed refers to the moving distance from the printer head to the stop position on each mode.	PW208NX :	Tear-Off	: 88 dots		Linerless	: 64 dots		Dispenser	: 0 dot	PW208mNX:	Tear-Off	: 66 dots		Linerless	: 30 dots	
PW208NX :	Tear-Off	: 88 dots														
	Linerless	: 64 dots														
	Dispenser	: 0 dot														
PW208mNX:	Tear-Off	: 66 dots														
	Linerless	: 30 dots														

Paper End (PW208NX only)	
Printing > Advanced > Paper End Select the sensor for detecting the paper end. Initial setting : Using I-Mark Setting options : Using I-Mark, Using Gap Using I-Mark: Use the I-Mark sensor (reflective type) to sense the paper end. Using Gap: Use the Gap sensor (transmissive type) to sense the paper end.	

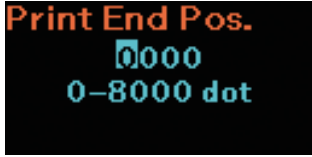
Prioritize	
<p>Printing > Advanced > Prioritize</p> <p>Set which takes priority, printer setting or command setting. Items for priority setting are print darkness, print speed, print offset, print mode and sensor type.</p> <p>Initial setting : Commands Setting options : Settings, Commands</p> <p>Settings : The printer's internal settings including the settings specified on the printer's display take priority. Commands : The printer settings according to the received data (commands) take priority.</p>	

Reprint	
<p>Printing > Advanced > Reprint</p> <p>Assign the reprint function to the button.</p> <p>Initial setting : Disabled Setting options : Enabled, Disabled</p> <p>Enabled: Enable the reprint function. Disabled: Disable the reprint function.</p> <hr/> <p> Note The previous data is lost if you power off the printer.</p> <hr/> <p>Reprint function If you have selected Enabled in Reprint, you can press the  button on the printing (online) screen to print the previous data again. In case there is no print data, the printer does not perform reprint.</p>	

Print End Pos. (Print End Position)	
<p>Printing > Advanced > Print End Pos.</p> <p>Set the print end position of media.</p> <p>Initial setting : 0 dot Setting range : 0 to 8000 dots</p> <hr/> <p> Notes</p> <ul style="list-style-type: none"> • When the sensor type is set to None, the function of the print end position becomes enabled. • The media stops at the position of the print stop position added with the value specified as the print end position. 	

Dispenser Mode	
<p>Printing > Advanced > Dispenser Mode</p> <p>Set the dispenser motion.</p> <p>Initial setting : Auto (PW208NX) None (PW208mNX)</p> <p>Setting options : Auto (PW208NX only), Manual (PW208mNX only), None</p> <p>Auto: When the print mode is set to Linerless or Dispenser (PW208NX only) (page 30), the printer starts next printing automatically after the printed media is removed.</p> <p>Manual: When the print mode is set to Linerless, press /  button to start next printing.</p> <p>None: When the printer mode is set to Linerless, the printer keeps on printing until all the received data is printed.</p> <hr/> <p> Note</p> <p>When None is selected in the Dispenser mode, the printer operates in Auto mode.</p> <hr/>	<p>For PW208NX:</p>  <p>For PW208mNX:</p> 



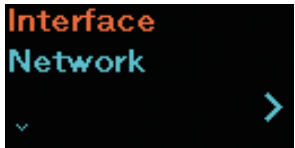

2.6.2 Interface Menu

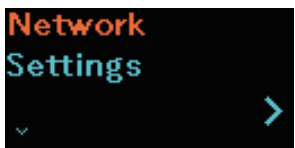
In the Interface menu, the setting items are as follows:

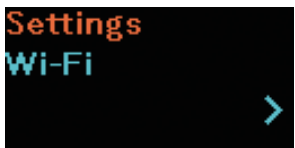
Interface			
1	Network (PW208NX only : Wireless LAN model)	Set the wireless LAN connection.	
2	USB	Set the USB connection.	
3	Bluetooth	Set the Bluetooth connection.	
4	NFC	Set the NFC function.	
5	Ignore CR/LF	Set to ignore CR/LF codes.	
6	Ignore CAN/DLE	Set to ignore CAN/DLE codes.	

Network (PW208NX only: Wireless LAN model)			
Interface > Network			
To use the wireless LAN for the interface between the host and the printer, set the following setting items:			
1	Settings	Set up the wireless LAN.	
2	Services	Set the port for connection, LPD, FTP or SNMP.	
3	Advanced	Set up the advanced function for the interface.	

Settings			
Interface > Network > Settings			
Set up the wireless LAN as follows:			
1	Wi-Fi	Set up the wireless LAN.	

Wi-Fi (Wireless LAN model)		
Interface > Network > Settings > Wi-Fi		
To set the wireless LAN, set the following setting items:		
1	IPv4	Configure the IPv4 for the wireless LAN.
2	IPv6	Configure the IPv6 for the wireless LAN. This item is not displayed when Wi-Fi Direct is selected.
3	Proxy	Configure the proxy for the wireless LAN.
4	WPS	Set the wireless LAN connection with the WPS (Wi-Fi Protected Setup) function. This item is not displayed when Wi-Fi Direct is selected.
5	Wi-Fi Direct	Set up the Wi-Fi Direct function. This item can be enabled only if you have selected Infrastructure in the Mode menu.
6	SSID	Display or set the SSID.
7	Hidden SSID	Display or set the Hidden SSID (stealth function), when you have selected Infrastructure in the Mode menu.
8	Mode	Set the communication mode of the wireless LAN.
9	Channel	Set the communication channel. This item can be enabled only if you have selected Ad Hoc in the Mode menu.
10	Security	Shows the security (encryption method) for the network. You cannot change the setting.
11	WEP Conf.	Set up the encryption. This item can be enabled only if you have selected WEP in the Security menu.
12	WPA Conf.	Set the WPA authentication. This item can be enabled only if you have selected WPA+WPA2 or WPA2 in the Security menu.
13	EAP Conf.	Set the EAP authentication. This item can be enabled only if you have selected Enterprise(802.1x) or CCKM in the WPA Conf. or you have selected Dynamic WEP in the Security menu.
<p>Note</p> <p>When you complete setting in each setting screen, press the  button to display the Wi-Fi screen.</p> <p>While "Save Setting?" is displayed, press /  button to enable the input value in each setting screen.</p> <p>When you press /  button or power off the printer before the Wi-Fi screen is displayed, the input content is canceled.</p>		

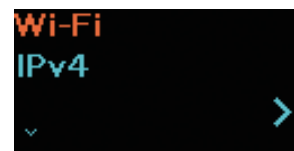

IPv4		
Interface > Network > Settings > Wi-Fi > IPv4		
To set IPv4 for the wireless LAN, the setting items are as follows:		
1	Mode	Select the IP address assignment method. This item is not displayed when Wi-Fi Direct is selected.
2	DHCP	You can press  /← button to get the IP address from the DHCP server. When Mode is set to DHCP, update the address. This item is not displayed when Wi-Fi Direct is selected.
3	IP Address	Display or set the IP Address. If you have selected DHCP in the Mode menu or Wi-Fi Direct is active, the IP address you received from the DHCP server is displayed on the screen. If you have selected Static in the Mode menu, set the IP address.
4	Netmask	Display or set the subnet mask address. If you have selected DHCP in the Mode menu or Wi-Fi Direct is active, the subnet mask address you received from the DHCP server is displayed on the screen. If you have selected Static in the Mode menu, set the subnet mask address.
5	Gateway	Display or set the default gateway address. If you have selected DHCP in the Mode menu or Wi-Fi Direct is active, the default gateway address you received from the DHCP server is displayed on the screen. If you have selected Static in the Mode menu, set the default gateway address.
6	DNS	Shows the primary address of the DNS server. You cannot change the setting. This item is not displayed when Wi-Fi Direct is selected.

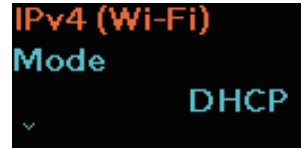

Mode	
Interface > Network > Settings > Wi-Fi > IPv4 > Mode	
Select the IP address assignment method. This item is not displayed when Wi-Fi Direct is selected.	
Initial setting	: DHCP
Setting options	: DHCP, Static
DHCP	: Automatically retrieve the IP address, gateway and subnet mask from the DHCP server.
Static	: Manually set the IP address, gateway and subnet mask.

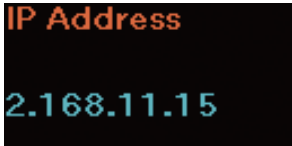
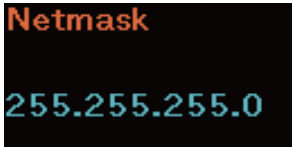
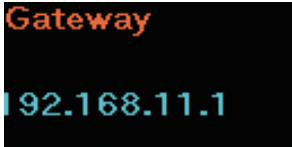

IP Address	
<p>Interface > Network > Settings > Wi-Fi > IPv4 > IP Address</p> <p>If you have selected DHCP in the Mode menu or Wi-Fi Direct is active, the IP address you received from the DHCP server is displayed on the screen. If you have selected Static in the Mode menu, set the IP address.</p> <p>Initial setting : 000.000.000.000 Setting range : 000.000.000.000 to 255.255.255.255</p>	 <p>IP Address 2.168.11.15</p>
Netmask	
<p>Interface > Network > Settings > Wi-Fi > IPv4 > Netmask</p> <p>If you have selected DHCP in the Mode menu or Wi-Fi Direct is active, the subnet mask address you received from the DHCP server is displayed on the screen. If you have selected Static in the Mode menu, set the subnet mask address.</p> <p>Initial setting : 255.255.255.0 Setting range : 128.0.0.0 to 255.255.255.254</p>	 <p>Netmask 255.255.255.0</p>
Gateway	
<p>Interface > Network > Settings > Wi-Fi > IPv4 > Gateway</p> <p>If you have selected DHCP in the Mode menu or Wi-Fi Direct is active, the default gateway address you received from the DHCP server is displayed on the screen. If you have selected Static in the Mode menu, set the default gateway address.</p> <p>Initial value : 000.000.000.000 Setting range : 000.000.000.000 to 255.255.255.255</p>	 <p>Gateway 192.168.11.1</p>

IPv6		
Interface > Network > Settings > Wi-Fi > IPv6		
To set IPv6 for the wireless LAN, the setting items are as follows: This item is not displayed when Wi-Fi Direct is selected.		
1	Mode	Select the IP address assignment method.
2	DHCP	You can press / button to get the IP address from the DHCP server. When Mode is set to DHCP, the address is updated.
3	IP Address	Shows the IP Address. You cannot change the setting.
4	Prefix Length	Display or set the prefix length. If you have selected Static in the Mode menu, the prefix length is selected and set.
5	Gateway	Shows the default gateway address. You cannot change the setting.
6	DNS	Shows the primary address of the DNS server. You cannot change the setting.

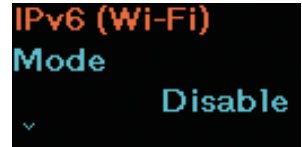

Mode	
Interface > Network > Settings > Wi-Fi > IPv6 > Mode	
Select the IP address assignment method.	
Initial setting : Disable	
Setting options : Disable , Auto, DHCP, Static	
Disable	: Disable the IPv6.
Auto	: Automatically generate the IP address and gateway (stateless mode).
DHCP	: Automatically retrieve the IP address, gateway and subnet mask from the DHCP server.
Static	: Shows the IP address and default gateway address.



Prefix Length	
Interface > Network > Settings > Wi-Fi > IPv6 > Prefix Length	
If you have selected Auto or DHCP in the Mode menu, the prefix length is displayed. If you have selected Static in the Mode menu, the prefix length is selected and set.	
Initial value : 64	
Setting range : 1 to 128	

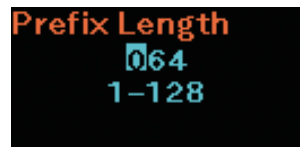

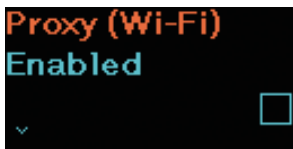

Proxy		
Interface > Network > Settings > LAN > Proxy		
To set the proxy for the LAN, the setting items are as follows:		
1	Enabled	Enable or disable use of proxy.
2	Server	Shows the proxy server address information. You cannot change the setting.
3	Exclude	Shows the address to be excluded from the proxy usage. You cannot change the setting.



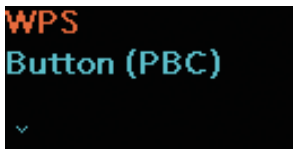

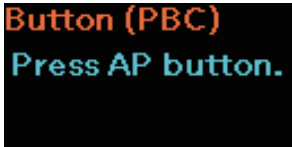
WPS		
Interface > Network > Settings > Wi-Fi > WPS		
To set the wireless LAN connection using the push button or PIN code method, the setting items are as follows: This item is not displayed when Wi-Fi Direct is selected.		
1	Button (PBC)	Set the wireless LAN connection using the push button method.
2	PIN	Set the wireless LAN connection using the PIN code method.
<p> Note</p> <p>Refer to the manual of the wireless LAN access point device for its operation.</p>		





Button (PBC)	
<p>Interface > Network > Settings > Wi-Fi > WPS > Button (PBC)</p> <p>Set the wireless LAN connection using the push button method.</p> <ol style="list-style-type: none">1. Select Button (PBC) in the WPS menu.2. When "Press AP button." is displayed on the screen, press the WPS button on the access point of the wireless LAN device.3. When the connection to the access point is established, "Successfully configured" appears on the screen. <hr/> <p> Note</p> <p>If the connection to the access point is failed, "Failed to find the Access Point" appears on the screen.</p> <hr/>	









PIN	
<p>Interface > Network > Settings > Wi-Fi > WPS > PIN</p> <p>Set the wireless LAN connection using the PIN code method.</p> <ol style="list-style-type: none">1. Select PIN in the WPS menu.2. When "Enter PIN on AP." appears on the screen, enter the PIN code to the access point of the wireless LAN displayed alternately on the screen.3. When the connection to the access point is established, "Successfully configured" appears on the screen. <hr/> <p> Note</p> <p>If the connection to the access point is failed, "Failed to find the Access Point" appears on the screen.</p> <hr/>	



Wi-Fi Direct		
Interface > Network > Settings > Wi-Fi > Wi-Fi Direct		
To set up the Wi-Fi Direct function, the setting items are as follows: The Wi-Fi Direct function is enabled only if you have selected Infrastructure in the Mode menu.		
1	Device Name	Shows the device name. You cannot change the setting.
2	Connect	Search and display a connectable device and then connect to the device.
3	Start Group	While <new> is displayed on the screen, press the  /← button to create and start a new persistent group. If the group is already started, this setting item is not displayed.
4	Button (PBC)	When a group has been started, set the wireless LAN connection using the push button method.
5	Disconnect	Disconnect the connected device. When a group has been started, disconnect the group.
6	Remove Group	Remove a group. Press the ► /→ button to select the group you want to remove, then press the  /← button to remove the group. If the group is already started, this setting item is not displayed.
7	SSID	When a group has been started, SSID is displayed. SSID is a device name. You cannot change the setting.
8	IP Address	When a group has been started, IP address is displayed. You cannot change the setting.
9	Passphrase	When a group has been started, passphrase is displayed. You cannot change the setting.

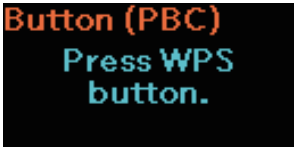

Connect	
Interface > Network > Settings > Wi-Fi > Wi-Fi Direct > Connect	
Search a connectable device and then connect to the device. The setting procedures are as follows:	
<ol style="list-style-type: none"> 1. Select Connect to search the connectable device names. 2. Press the ► /→ button to select the device name you want to connect, and then press the /← button to decide the device. 3. Follow the instructions of the printer or the device you want to connect, complete the connection. 	
<p> Note</p> <p>You can connect to the maximum of 10 devices.</p>	

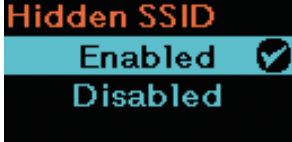

Start Group	
<p>Interface > Network > Settings > Wi-Fi > Wi-Fi Direct > Start Group</p> <p>Use the grouping function to connect to a smartphone, tablet, or computer. The setting procedures are as follows:</p> <ol style="list-style-type: none"> 1. Select Start Group, and press the /← button. 2. Press the  button to select the group to which you want to add a smartphone, tablet, or computer, or <new>, and then press the /← button to decide the group. 3. From the Wi-Fi Direct setting items, check the IP Address and Passphrase settings and take a note of them. 4. In the address of the browser of a smartphone, tablet, or computer you want to connect, input the IP address and passphrase you checked in step 3. 5. Follow the instructions of the smartphone, tablet or computer, and then complete the connection. <hr/> <p> Notes</p> <ul style="list-style-type: none"> • You can connect to the maximum of 10 devices. • When the group has been started, Start Group is not displayed. When you disconnect the connection with Disconnect, Start Group is displayed. 	
Button (PBC)	
<p>Interface > Network > Settings > Wi-Fi > Wi-Fi Direct> Button (PBC)</p> <p>Set the wireless LAN connection using the push button method.</p> <ol style="list-style-type: none"> 1. When “Press WPS button.” is displayed on the screen, press the WPS button on the access point of the wireless LAN device. 2. When the connection to the access point is established, “Connected with xxxxx” appears on the screen.* <p>* : The name of the access point is displayed in “xxxxx “.</p> <hr/> <p> Note</p> <p>If the connection to the access point is failed, “WPS timeout” appears on the screen.</p>	
SSID	
<p>Interface > Network > Settings > Wi-Fi > SSID</p> <p>Display or set the SSID.</p> <p>Search and set the connectable devices. If no connectable devices are found, SSID is displayed.</p> <p>Initial setting : SATO_PRINTER (The printer’s SSID is displayed.) Setting options : Shows connectable devices.</p>	

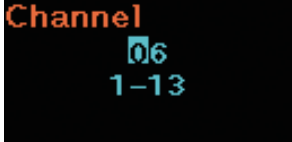
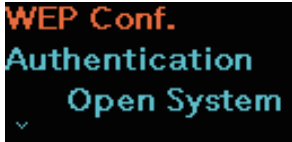
Hidden SSID		
Interface > Network > Settings > Wi-Fi > Hidden SSID		
<p>Display or set the Hidden SSID (stealth function), when Infrastructure is selected in the Mode.</p> <p>Initial setting : Enabled</p> <p>Setting options : Enabled, Disabled</p> <p>Enabled: Stop beacon signals.</p> <p>Disabled: Transmit beacon signals.</p>		
Mode		
Interface > Network > Settings > Wi-Fi > Mode		
<p>Set the communication method of the wireless LAN.</p> <p>Initial setting : Ad-hoc</p> <p>Setting options : Infrastructure, Ad-hoc</p> <p>Infrastructure : Communication is performed via access point infrastructure mode.</p> <p>Ad-hoc : Communication is performed in Ad-hoc mode.</p> <hr/> <p><input type="checkbox"/> Note</p> <p>When switching the Mode, you need to restart the printer.</p>		
Channel		
Interface > Network > Settings > Wi-Fi > Channel		
<p>Set the communication channel.</p> <p>Channel can be set only if you have selected Ad-hoc in the Mode menu.</p> <p>Initial setting : 6</p> <p>Setting range : 1 to 11</p>		
WEP Conf.		
Interface > Network > Settings > Wi-Fi > WEP Conf.		
To display the WEP authentication if you have selected WEP in the Security menu, the setting items are as follows:		
1	Authentication	
2	Key Index	Shows the WEP Key Index. You cannot change the setting.

WPA Conf.		
Interface > Network > Settings > Wi-Fi > WPA Conf.		
Display and set the WPA authentication if you have selected WPA+WPA2 or WPA2 in the Security menu.		
1	WPA Authentication	Shows the WPA authentication method. You cannot change the setting.
2	EAP Conf.	Shows the functions for EAP only if you have selected Enterprise (802.1x) or CCKM in the WPA Authentication menu. You cannot change the setting.



EAP Conf.		
Interface > Network > Settings > Wi-Fi > WPA Conf. > EAP Conf.		
Interface > Network > Settings > Wi-Fi > EAP Conf.		
Shows the functions for EAP only if you have selected Enterprise (802.1x) or CCKM in the WPA Authentication menu, or if you have selected Dynamic WEP in the Security menu. You cannot set the items of EAP Conf.		
1	EAP Mode	Shows the EAP Mode (authentication mode).
2	Inner Method	Shows the inner method only if you have selected Fast in the EAP Mode.
3	Inner Method	Shows the inner method only if you have selected PEAP in the EAP Mode menu.
4	Inner Method	Shows the inner method only if you have selected TTLS in the EAP Mode menu.
5	Username	Shows the EPA authentication user name.
6	Anon.Outer ID	Shows the external anonymous ID only if you have selected FAST, PEAP or TTLS in the EAP Mode menu.
7	Verify Server Cert.	Shows whether server authentication is enabled or disabled only if you have selected FAST, PEAP, TLS or TTLS in the EAP Mode menu.
8	PAC Auto Provisioning	Shows whether PAC Auto Provisioning is enabled or disabled only if you have selected FAST in the EAP Mode menu.



Services		
Interface > Network > Services		
To set the port for connection, LPD or FTP, the setting items are as follows:		
1	Ports	Set the ports numbers.
2	LPD	Set up the functions for LPD.
3	FTP	Set up the functions for FTP.

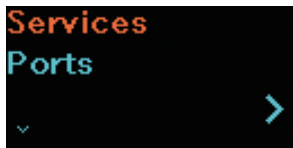

Ports		
Interface > Network > Services > Ports		
To set the port numbers, the setting items are as follows:		
1	Port1	Set the port number for Port1.
2	Port2	Set the port number for Port2.
3	Port3	Set the port number for Port13.
4	Flow Control	Set the communication protocol.

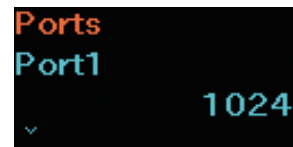

Port1	
Interface > Network > Services > Ports > Port1	
Set the port number for Port1. Port 2 and port 3 must be set to different values.	
Initial value : 1024 Setting range : 1-1024, 1026-9099, 9101-65535	
<hr/>  Note We recommend that you set 1024 or larger value for a port number. <hr/>	

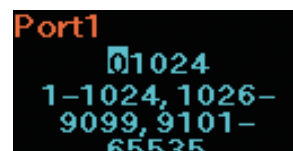



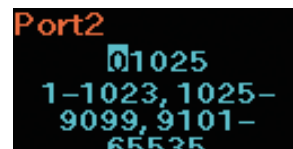

Port2	
Interface > Network > Services > Ports > Port2	
Set the port number for Port2. Port 1 and port 3 must be set to different values.	
Initial value : 1025 Setting range : 1-1023, 1025-9099, 9101-65535	
<hr/>  Note We recommend that you set 1024 or larger value for a port number. <hr/>	

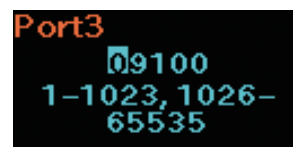

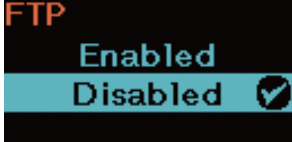

Port3	
Interface > Network > Services > Ports > Port3	
Set the port number for Port3. Port 1 and port 2 must be set to different values.	
Initial value : 9100 Setting range : 1-1023, 1026-65535	
<hr/>  Note We recommend that you set 1024 or larger value for a port number. <hr/>	





Flow Control	
<p>Interface > Network > Services > Ports > Flow Control</p> <p>Set the communication protocol.</p> <p>Initial setting : Status4</p> <p>Setting options : Status4, Status3, None</p>	
LPD	
<p>Interface > Network > Services > LPD</p> <p>Set up the functions for LPD.</p> <p>Initial setting : Enabled</p> <p>Setting options : Enabled, Disabled</p> <p>Enabled: Enable the functions for LPD.</p> <p>Disabled: Disable the functions for LPD.</p>	
DNS Lookup	
<p>Interface > Network > Services > LPD > DNS Lookup</p> <p>Enable or disable the DNS Lookup function.</p> <p>Initial value : Disabled</p> <p>Setting options : Enabled, Disabled</p> <p>Enabled: Enable the DNS Lookup function.</p> <p>Disabled: Disable the DNS Lookup function.</p>	
FTP	
<p>Interface > Network > Services > FTP</p> <p>Set up the functions for FTP.</p> <p>Initial setting : Disabled</p> <p>Setting options : Enabled, Disabled</p> <p>Enabled: Enable the functions for FTP.</p> <p>Disabled: Disable the functions for FTP.</p>	

FTP Timeout	
Interface > Network > Services > FTP > FTP Timeout	
<p>Set the connection timeout period between the printer's FTP server and clients. Specify the maximum number of seconds that the printer's FTP server will allow clients to stay connected without receiving any data on either the control or data connection.</p> <p>Initial value : 300 sec. Setting range : 10 to 3600 seconds</p>	

Advanced		
Interface > Network > Advanced		
Set up the advanced function for the interface.		
1	ARP Announce	Set the ARP announcement.

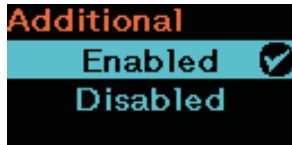
ARP Announce		
Interface > Network > Advanced > ARP Announce		
To set ARP announcement, the setting items are as follows:		
1		Additional
2	Periodic	Set the periodic timing for ARP announcement.

Additional		
Interface > Network > Advanced > ARP Announce > Additional		
Set the additional ARP announcement.		
Initial setting	: Enabled	
Setting options	: Enabled, Disabled	

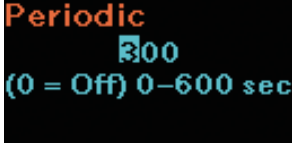



Periodic	
<p>Interface > Network > Advanced > ARP Announce > Periodic</p> <p>Set the periodic timing for ARP announcement.</p> <p>Initial value : 300 sec. Setting range : 0 to 600 seconds</p> <hr/> <p> Note</p> <p>If you set the item to 0, the interval of announcement is set to off.</p>	



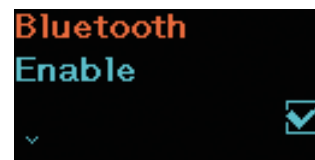

USB			
<p>Interface > USB</p> <p>Set the USB connection.</p>			
<table border="1" style="width: 100%;"> <tr> <td style="width: 5%;">1</td> <td style="width: 20%;">Flow Control</td> <td>Set the communication protocol.</td> </tr> </table>		1	Flow Control
1	Flow Control	Set the communication protocol.	

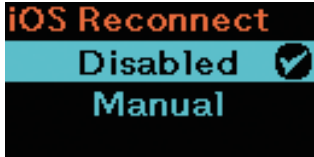
Flow Control	
<p>Interface > USB > Flow Control</p> <p>Set the communication protocol.</p> <p>Initial setting : Status4 Setting options : Status4, None</p>	

Bluetooth		
Interface > Bluetooth		
To set the Bluetooth connection, the setting items are as follows:		
1	Enable	Enable or disable the functions for Bluetooth.
2	Name	Shows the device name for the printer when Bluetooth function is enabled. You cannot change the setting.
3	PIN Code	Shows the PIN code when Bluetooth function is enabled. You cannot change the setting.
4	BD Address	Shows the BD address of this printer when Bluetooth function is enabled. You cannot change the setting.
5	Firm Version	Shows the firmware version of the Bluetooth when Bluetooth function is enabled. You cannot change the setting.
6	Host BD Addr	Shows the Host BD address when Bluetooth function is enabled. You cannot change the setting.
7	IAP Ready	Shows the operational status of the IAP authentication chip, enabling the communication between an iOS-equipped device and a Bluetooth device. When the communication is enabled, a check mark is displayed. You cannot change the setting.
8	iOS Reconnect	Disable the iOS reconnect function or set to the Manual mode.
9	Authentication	Set the authentication level when Enable is set to Enabled.
10	ISI	Set the ISI communication parameter when Bluetooth function is enabled.
11	ISW	Set the ISW communication parameter when Bluetooth function is enabled.
12	PSI	Set the PSI communication parameter when Bluetooth function is enabled.
13	PSW	Set the PSW communication parameter when Bluetooth function is enabled.
14	Give BD Address	When enabled, the BD address is added to the printer device name.
15	IO Compatible	Set the authentication process in Secure Simple Pairing.
16	CRC Mode	Set up the CRC check function when Bluetooth function is enabled.
17	Flow Control	Set the communication protocol when Bluetooth function is enabled.

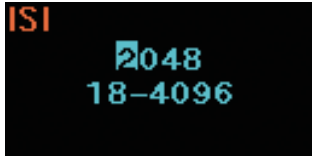

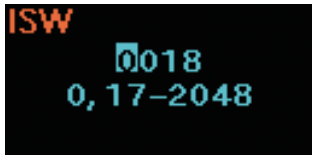

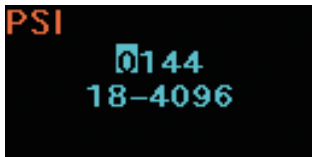
Enable	
<p>Interface > Bluetooth > Enable</p> <p>Set up the functions for Bluetooth.</p> <p>Initial setting : Enabled</p> <p>Setting options : Enabled, Disabled</p> <p>Enabled: Enable the Bluetooth function.</p> <p>Disabled: Disable the Bluetooth function.</p>	
iOS Reconnect	
<p>Interface > Bluetooth > iOS Reconnect</p> <p>Disable the iOS reconnect function or set to the Manual mode.</p> <p>Initial setting : Disabled</p> <p>Setting options: Enabled, Disabled</p> <p>Disabled : The printer does not perform iOS reconnection. You need try reconnection from iOS device.</p> <p>Manual : The printer perform iOS reconnection when the printer is turned on or it switches to online or offline.</p> <hr/> <p> Note</p> <p>Every time a reconnection is to be established, iOS authentication occurs. If you power off the printer by removing a battery or other accidental operation during the authentication on process, it may take a maximum of 127 seconds to establish the next reconnection.</p>	
Authentication	
<p>Interface > Bluetooth > Authentication</p> <p>Set the authentication level when Enable is set to Enabled.</p> <p>Initial setting : None</p> <p>Setting options: None, Level 2-1, Level 2-2, Level 3, Level 4</p> <p>None : No authentication needed.</p> <p>Level 2-1 : PIN code authentication, service level, no encryption</p> <p>Level 2-2 : PIN code authentication, service level, with encryption</p> <p>Level 3 : PIN code authentication, link level, no encryption</p> <p>Level 4 : Secure Simple Pairing (SSP), link level, no encryption (Connection is possible with a device not compatible for SSP.)</p> <p>About Secure Simple Pairing</p> <p>Secure Simple Pairing is the pairing system that operates when the Level 4 is selected as the Bluetooth authentication level. By using the Secure Simple Pairing, simpler and safer pairing is possible.</p> <hr/> <p> Note</p> <p>Secure Simple Pairing can be set only on the Online or Offline screen.</p>	

ISI	
<p>Interface > Bluetooth > ISI</p> <p>Set the ISI communication parameter when Enable is set to Enabled. Set to a value that is higher than the ISW communication parameter setting value.</p> <p>Initial setting : 2048 Setting range : 18 to 4096</p> <hr/> <p> Notes</p> <ul style="list-style-type: none"> • The setting is even only. When you set an odd number, the printer operates the value of the set odd number minus 1. • If you set ISI to 0, also set ISW to 0 simultaneously. • When both ISI and ISW are set to 0, they are not displayed in the device search from a PC and others. <hr/>	
ISW	
<p>Interface > Bluetooth > ISW</p> <p>Set the ISW communication parameter when Enable is set to Enabled. Set to a value that is lower than the ISI communication parameter setting. Setting range varies depending on the ISI communication parameter setting value.</p> <p>Initial value : 18 Setting range : 0 or 17 to 2048</p> <hr/> <p> Notes</p> <ul style="list-style-type: none"> • If you set ISW to 0, also set ISI to 0 simultaneously. • When both ISI and ISW are set to 0, they are not displayed in the device search from a PC and others. <hr/>	
PSI	
<p>Interface > Bluetooth > PSI</p> <p>Set the PSI communication parameter when Enable is set to Enabled. Set to a value that is higher than the PSW communication parameter setting value.</p> <p>Initial value : 144 Setting range : 18 to 4096</p> <hr/> <p> Note</p> <p>The setting is even only. When you set an odd number, the printer operates the value of the set odd number minus 1.</p> <hr/>	

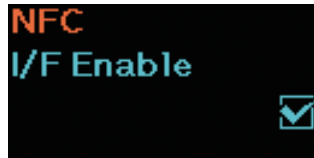
PSW	
<p>Interface > Bluetooth > PSW</p> <p>Set the PSW communication parameter when Enable is set to Enabled. Set to a value that is lower than the PSI communication parameter setting. Setting range varies depending on the PSI communication parameter setting value.</p> <p>Initial value : 18 Setting range : 17 to 144</p>	
Give BD Address	
<p>Interface > Bluetooth > Give BD Address</p> <p>When this function is enabled, BD address is added to the printer device name.</p> <p>Initial value : Enabled Setting options : Enabled, Disabled</p> <p>Example (When BD address is XXXXXXXXXXXX) Enabled : SATO_PRINTER_XXXXXXXXXX Disabled : SATO_PRINTER</p>	
IO Compatible	
<p>Interface > Bluetooth > IO Compatible</p> <p>Set the authentication process in Secure Simple Pairing.</p> <p>Initial setting : Disabled Setting options : Enabled, Disabled</p> <p>Enabled : The pass key is not displayed in Secure Simple Pairing. Disabled : The pass key is displayed in Secure Simple Pairing.</p>	
CRC Mode	
<p>Interface > Bluetooth > CRC Mode</p> <p>Enable or disable the functions for CRC when Enable is set to Enabled.</p> <p>Initial setting : Disabled Setting options : Enabled, Disabled</p> <p>Enabled : Enable the CRC function. Disabled : Disable the CRC function.</p>	
Flow Control	
<p>Interface > Bluetooth > Flow Control</p> <p>Set the communication protocol when Enable is set to Enabled.</p> <p>Initial setting : Status4 Setting options : Status3, Status4, None</p>	

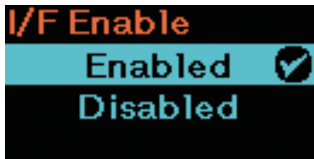
NFC	
<p>Interface > NFC</p> <p>Set the NFC (Near Field Communication) function if the NFC interface (Optional) is installed.</p> <p>The setting items are as follows:</p> <p>I/F Enable : Enable or disable the NFC interface.</p>	

I/F Enable	
<p>Interface > NFC > I/F Enable</p> <p>Enable or disable the NFC Interface.</p> <p>The setting items are as follows:</p> <p>Enabled : Enable the NFC interface.</p> <p>Disabled : Disable the NFC interface.</p> <hr/> <p> Note</p> <p>Even when Disabled is set, the NFC tag setting is in effect.</p>	

Ignore CR/LF	
<p>Interface > Ignore CR/LF</p> <p>Ignore or acknowledge the CR/LF code of the received data.</p> <p>Initial setting : Disabled</p> <p>Setting options : Enabled, Disabled</p> <p>Enabled : Ignore the CR/LF code.</p> <p>Disabled : Do not ignore the CR/LF code.</p>	

Ignore CAN/DLE	
<p>Interface > Ignore CAN/DLE</p> <p>Ignore or acknowledge the CAN/DLE code of the received data.</p> <p>Initial setting : Disabled</p> <p>Setting options : Enabled, Disabled</p> <p>Enabled : Ignore the CAN/DLE code.</p> <p>Disabled : Do not ignore the CAN/DLE code.</p>	

2.6.3 Battery Menu

In the Battery menu, the setting items are as follows:

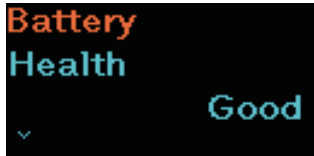
Battery			
1	Health	Shows the battery condition. The condition is displayed with Good, Replace and Poor. You cannot change the setting.	
2	Cycle Counts	Shows the cycle count (charge/discharge cycle). You cannot change the setting.	
3	Eco Charge	Set up the Eco Charge function.	
4	Full Charge P-Off	Set up the printer's power-off function after charging is complete.	
<p>Battery condition (Health)</p> <p>Good : Battery is in a good condition for use.</p> <p>Replace : Battery is in a condition that requires replacement.</p> <p>Poor : Battery is deteriorated and in a condition that requires replacement.</p>			

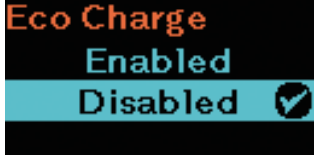
Eco Charge	
<p>Battery > Eco Charge</p> <p>Set up the Eco Charge function. The Eco Charge function is designed to extend the battery life by keeping the after-charged volume of the battery a little lower than the fully charged volume, thus delaying the degree of deterioration.</p> <p>Initial setting : Disabled Setting options : Enabled, Disabled</p> <p>Enabled : Enable the Eco Charge function. Disabled : Disable the Eco Charge function.</p> <hr/> <p> Note</p> <p>When using the printer being set on the charging cradle, Enabled is recommended.</p> <hr/>	

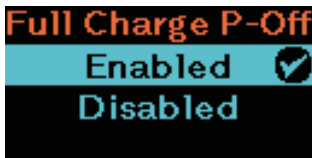
Full Charge P-Off	
<p>Battery > Fully Charge Power-Off</p> <p>Set up the printer's power-off function after charging is complete. While the printer is paused in printing (online) or offline (stop) screen, the printer powers off 3 seconds after it completes charging.</p> <p>Initial setting : Enabled Setting options : Enabled, Disabled</p> <p>Enabled : The printer powers off automatically after it completes charging. Disabled : The printer does not power off automatically after it completes charging.</p> <p>Conditions to disable the Fully-Charge Power-Off function</p> <ul style="list-style-type: none"> • While the printer is printing or feeding the media. • While the printer button is being used. • During adjustment or setting mode. • While the printer receives the data. • When the temperature in the printer exceeds the tolerance range (error 1065). • When an AC adapter is removed. <hr/> <p> Note</p> <p>When using the printer being set on the charging cradle, set Full Charge P-Off to Disabled.</p> <hr/>	

2.6.4 Applications Menu

In the Applications menu, the setting items are as follows:

Applications		
1	Protocol	Set the protocol the printer uses.
2	SBPL	Set the SBPL printer commands.
3	SZPL	Set the SZPL printer commands.
4	SCPL	Set the SCPL printer commands.
5	SPOS	Set the SPOL printer commands.



Protocol
<p>Applications > Protocol</p> <p>Set the protocol the printer uses.</p> <p>Initial setting : SBPL</p> <p>Setting options : SBPL, SZPL, SCPL, SPOS</p> <p>SBPL: Set when you use the SBPL printer command.</p> <p>SZPL: Set when you use the SZPL printer command.</p> <p>SCPL: Set when you use the SCPL printer command.</p> <p>SPOS: Set when you use the SPOS printer command.</p>



SBPL		
<p>Applications > SBPL</p> <p>To use SBPL as the printer command, set the following items:</p> <p>* For details of SBPL commands, contact your SATO reseller or technical support center.</p>		
1	Show Error	Enable or disable the command error indication.
2	Standard Code	Set the protocol code (control code).
3	Orientation	Set the layout for printing.
4	Font Settings	Set the font.
5	Compatible	Set the compatible code.

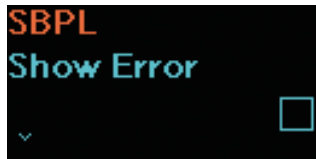

Show Error	
<p>Applications > SBPL > Show Error</p> <p>Enable or disable the command error indication.</p> <p>Initial setting : Disabled</p> <p>Setting options : Enabled, Disabled</p> <p>Enabled : A command error is displayed and the printing stops.</p> <p>Disabled : A status icon is displayed and the printing continues.</p>	

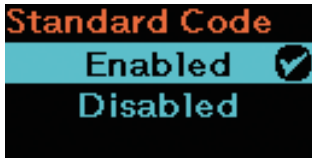
Standard Code	
<p>Applications > SBPL > Standard Code</p> <p>Set the protocol code (control code).</p> <p>Initial setting : Enabled</p> <p>Setting options : Enabled, Disabled</p> <p>Enabled : Use a standard code.</p> <p>Disabled : Use a non-standard code.</p>	

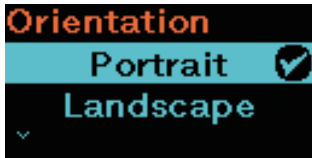
Orientation	
<p>Applications > SBPL > Orientation</p> <p>Set the layout for printing.</p> <p>Initial setting : Portrait</p> <p>Setting options : Portrait, Landscape, Inv. Portrait, Inv. Landscape</p>	

Font Settings		
<p>Applications > SBPL > Font Settings</p> <p>To set the font, the setting items are as follows:</p>		
1	Zero Slash	Set whether to print the number zero (0) with or without a slash (/).
2	Kanji	Set the kanji code to be used.
3	Proportional	Set the proportional character pitch (width) for printing.
4	Code Page	Set the code page to be used.
5	€	Set the code of the European currency symbol.



Zero Slash	
<p>Applications > SBPL > Font Settings > Zero Slash</p> <p>Set whether to print the number zero (0) with or without a slash (/).</p> <p>Initial setting : Enabled</p> <p>Setting options : Enabled, Disabled</p> <p>Enabled : Print zero with a slash (∅)</p> <p>Disabled : Print zero without a slash (0).</p>	

Kanji		
<p>Applications > SBPL > Font Settings > Kanji</p> <p>In the Printing menu, the setting items are as follows:</p>		
1	Kanji Set	Set the kanji character set to be used.
2	Character Code	Set the kanji character code to be used.
3	Kanji Style	Set the kanji character style to be used.

Kanji Set	
<p>Applications > SBPL > Font Settings > Kanji > Kanji Set</p> <p>Set the kanji character set to be used.</p> <p>Initial setting : GB18030</p> <p>Setting options : JP-JISX0208, JP-JISX0213, GB18030, BIG5, KSC5601</p>	

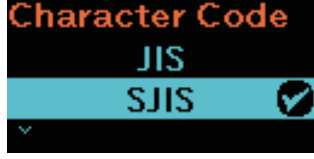
Character Code	
<p>Applications > SBPL > Font Settings > Kanji > Character Code</p> <p>Set the kanji character code to be used.</p> <p>The options vary depending on the kanji code set in the Kanji Set:</p> <p>Initial setting</p> <p>When set to JP-JISX0208, JP-JISX0213 : SJIS</p> <p>When set to GB18030 : GB18030</p> <p>When set to BIG5 : BIG5</p> <p>When set to KSC5601 : KSC5601</p> <p>Setting options</p> <p>When set to JP-JISX0208 : JIS, SJIS, UTF-16</p> <p>When set to JP-JISX0213 : SJIS, UTF-16</p> <p>When set to GB18030 : GB18030</p> <p>When set to BIG5 : BIG5</p> <p>When set to KSC5601 : KSC5601</p>	

Kanji Style	
<p>Applications > SBPL > Font Settings > Kanji > Kanji Style</p> <p>Set the kanji character style to be used.</p> <p>Initial setting : Gothic</p> <p>Setting options : Mincho, Gothic</p>	

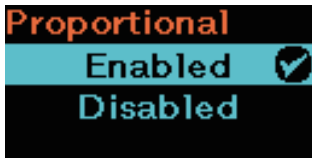
Proportional	
<p>Applications > SBPL > Font Settings > Proportional</p> <p>Set whether to print each character using a different pitch (width) or the same pitch (width).</p> <p>Initial setting : Enabled</p> <p>Setting options : Enabled, Disabled</p> <p>Enabled : Print each character with a different pitch (width) for a character (Proportional Pitch).</p> <p>Disabled : Print all characters with the same width.</p>	

Code Page	
<p>Applications > SBPL > Font Settings > Code Page</p> <p>Set the code page to be used.</p> <p>Initial setting : 858</p> <p>Setting options : UTF-8, 858, 8859-1, 8859-2, 8859-9, 737, 855, 850, 852, 857, 866, 1250, 1251, 1252, 1253, 1254, 1257, 869, X201</p>	

€	
<p>Applications > SBPL > Font Settings > €</p> <p>Set the code of the European currency symbol.</p> <p>Initial setting : d5</p> <p>Setting options : 0 to ff (hexadecimal)</p>	

Compatible	
Applications > SBPL > Compatible	
Set the compatible code for SBPL.	
1	CODE128(C)
2	Call Font/Log
3	QTY Timing
4	Character Pitch

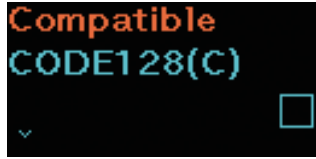

CODE128(C)	
Applications > SBPL > Compatible > CODE128(C)	
Set whether the printer allows an odd-number digit and performs printing by zero-filling the number, when the start code of CODE128 is C.	
Initial setting	: Disabled
Setting options	: Enabled, Disabled
Enabled	: Allow odd-number digit and perform printing with zero-filling the number.
Disabled	: Odd-number digit is not allowed. A command error occurs and barcode is not be printed.

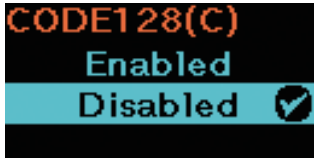

Call Font/Log	
Applications > SBPL > Compatible > Call Font/Logo	
Set how to process the character code specified by printing order command (ESC-RF) in calling font/logo.	
Initial setting	: Disabled
Setting options	: Enabled, Disabled
Enabled	: The character code is processed in little ending format.
Disabled	: The character code is processed in big ending format.



QTY Timing	
Applications > SBPL > Compatible > QTY Timing	
Set the compatibility in timing to update QTY.	
Initial setting	: Disabled
Setting options	: Enabled, Disabled
Enabled	: QTY is updated after the printer completes printing.
Disabled	: QTY is updated after the operation is complete when the Mode is Dispenser or Tear-Off. Even after the printer does not print because of an error, QTY is updated.

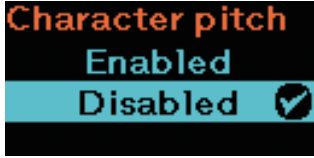

Character Pitch	
Applications > SBPL > Compatible > Character Pitch	
<p>Set the valid range in specifying a pitch between characters (ESC+P).</p> <p>Initial setting : Disabled</p> <p>Setting options : Enabled, Disabled</p> <p>Enabled : The valid range in specifying pitch between characters (ESC+P) is valid until you make a next character pitch setting.</p> <p>Disabled : The character pitch setting (ESC+P) is canceled and reset to the initial setting when next character is input or a barcode is specified.</p>	

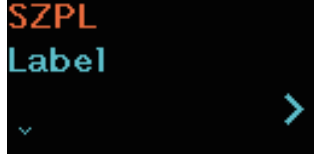
SZPL	
Applications > SZPL	
To use SZPL as the printer command, set the following items:	
1 Label	
2 Caret	
3 Delimiter	
4 Tilde	
5 Clock Format	
6 Default Font	

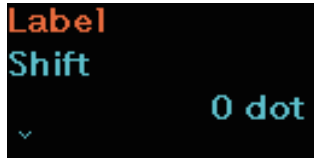
Label	
Applications > SZPL > Label	
Set the print position.	
The setting items are as follows:	
1 Shift	
2 Top	

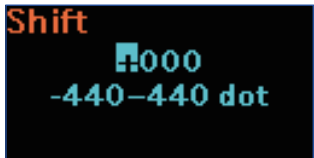
Shift	
Applications > SZPL > Label > Shift	
Set the shift offset position of the label.	
The setting range varies depending on the print resolution of the printer.	
Initial value : 0	
Setting range : -440 to 0 to +440 dots	

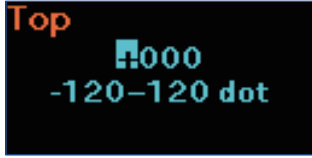
Top	
<p>Applications > SZPL > Label > Top</p> <p>Set the top offset position of the label.</p> <p>Initial value : 0</p> <p>Setting range : -120 to 0 to 120</p>	

Caret	
<p>Applications > SZPL > Caret</p> <p>Set the caret (^) code.</p> <p>Initial value : 94</p> <p>Setting range : 0 to 255</p>	

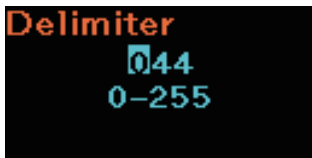
Delimiter	
<p>Applications > SZPL > Delimiter</p> <p>Set the delimiter (,) code.</p> <p>Initial value : 44</p> <p>Setting range : 0 to 255</p>	

Tilde	
<p>Applications > SZPL > Tilde</p> <p>Set the tilde (~) code.</p> <p>Initial value : 126</p> <p>Setting range : 0 to 255</p>	

Clock Format	
<p>Applications > SZPL > Clock Format</p> <p>Set the date format.</p> <p>Initial value : (none)</p> <p>Setting range : (none), MM/DD/YY (24-hour clock), MM/DD/YY (12-hour clock), DD/MM/YY (24-hour clock), DD/MM/YY (12-hour clock)</p>	

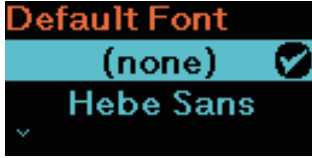
Default Font	
Applications > SZPL > Default Font	
Select a default font from the list for when printing using a multilingual font contained in the printer.	
Initial value : (none)	
	 A screenshot of a printer's configuration menu. The title is 'Default Font'. There are two options: '(none)' which is highlighted in blue and has a checkmark icon to its right, and 'Hebe Sans' which is below it. A small downward arrow is visible at the bottom left of the 'Hebe Sans' option.

2.6.5 System Menu

In the System menu, the setting items are as follows:

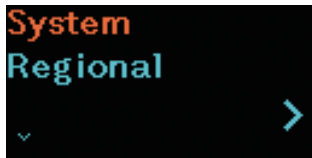
System			
1	Regional	Set the display language and unit.	
2	Notifications	Set up the function to notify when to perform cleaning and parts replacement.	
3	Sound	Set the buzzer sound.	
4	Energy Saving	Set the period before the printer enters energy saving mode.	
5	Show Total Cnt	Enable or disable the indication of the total print count.	
6	Show Large Icons	Set the large icon display.	
7	Password	Set the password.	

Regional				
System > Regional		To set the display language and unit, the setting items are as follows:		
1	Messages	Set the display language of the display.		
2	Unit	Set the unit of length for indication.		

Messages				
System > Regional > Messages		Set the display language of the display.		
Initial setting : English, US		Setting options : Japanese, English, US		

Unit				
System > Regional > Unit		Set the unit of length for indication on the display.		
Initial setting : dot		Setting options : dot, in (inch), mm		

Notifications		
System > Notifications		
To set up the function to notify the timing of cleaning and parts replacement, the setting items are as follows:		
1	Clean Head	Notify when the print head needs to be cleaned.
2	Change Head	Notify when the print head needs to be replaced.
3	Change Platen	Notify when the platen roller needs to be replaced.

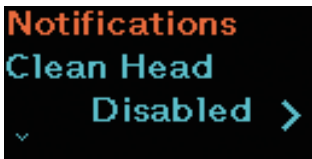

Clean Head		
System > Notifications > Clean Head		
To notify when the print head needs to be cleaned, the setting items are as follows:		
1	Clean Head	Enable or disable the notification function about when the print head needs to be cleaned.
2	Head Interval	Set the notification interval about when the print head needs to be cleaned. You can change settings only if you have selected Enabled in the Clean Head.
3	Head Counter	Shows the current print distance. You cannot change the setting.

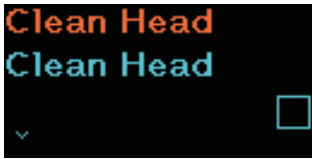

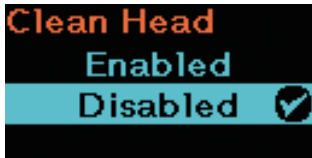

Clean Head		
System > Notifications > Clean Head > Clean Head		
Enable or disable the notification function about when the print head needs to be cleaned.		
Initial setting : Disabled		
Setting options : Enabled, Disabled		
Enabled : Enable the notification function.		
Disabled : Disable the notification function.		

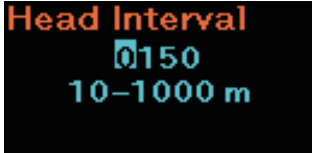

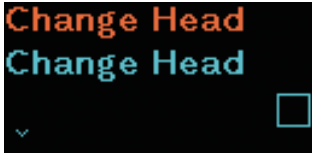

Head Interval	
<p>System > Notifications > Clean Head > Head Interval</p> <p>Set the notification interval about when the print head needs to be cleaned. When the print distance after the counter is reset reaches to the set value, a status icon for notifications is displayed. You can change settings only if you have selected Enabled in the Clean Head > Clean Head.</p> <p>Initial value : 150 m Setting range : 10 to 1000 m</p> <hr/> <p> Note</p> <p>For details on notifications, see “3.4 Notifications” (page 139).</p>	

Change Head		
System > Notifications > Change Head		
To notify when the print head needs to be replaced, the setting items are as follows:		
1	Change Head	Enable or disable the notification function about when the print head needs to be replaced.
2	Head Interval	Set the notification interval about when the print head needs to be replaced. You can change settings only if you have selected Enabled in the Change Platen > Change Platen.
3	Head Counter	Shows the current print distance. You cannot change the setting.





Change Head	
<p>System > Notifications > Change Head > Change Head</p> <p>Enable or disable the notification function about when the print head needs to be replaced.</p> <p>Initial setting : Disabled Setting options : Enabled, Disabled</p> <p>Enabled : Enable the notification function. Disabled : Disable the notification function.</p>	

Head Interval	
<p>System > Notifications > Change Head > Head Interval</p> <p>Set the notification interval about when the print head needs to be replaced. When the print distance after the counter is reset reaches to the set value, a status icon for notifications is displayed.</p> <p>You can change settings only if you have selected Enabled in the Clean Head > Clean Head.</p> <p>Initial value : 30 km Setting range : 1 to 30 km</p> <hr/> <p> Note</p> <p>For details on notifications, see “3.4 Notifications” (page 139).</p>	

Change Platen				
<p>System > Notifications > Change Platen</p> <p>To notify when the platen roller needs to be replaced, the setting items are as follows:</p>				
1	<table border="1"> <tr> <td>Change Platen</td> <td>Enable or disable the notification function about when the platen roller needs to be replaced.</td> </tr> </table>		Change Platen	Enable or disable the notification function about when the platen roller needs to be replaced.
Change Platen	Enable or disable the notification function about when the platen roller needs to be replaced.			
2	<table border="1"> <tr> <td>Platen Interval</td> <td>Set the notification interval about when the platen roller needs to be replaced. You can change settings only if you have selected Enabled in the Change Platen > Change Platen.</td> </tr> </table>		Platen Interval	Set the notification interval about when the platen roller needs to be replaced. You can change settings only if you have selected Enabled in the Change Platen > Change Platen.
Platen Interval	Set the notification interval about when the platen roller needs to be replaced. You can change settings only if you have selected Enabled in the Change Platen > Change Platen.			
3	<table border="1"> <tr> <td>Platen Counter</td> <td>Shows the current distance the platen roller has fed. You cannot change the setting.</td> </tr> </table>	Platen Counter	Shows the current distance the platen roller has fed. You cannot change the setting.	
Platen Counter	Shows the current distance the platen roller has fed. You cannot change the setting.			

Change Platen	
<p>System > Notifications > Change Platen > Change Platen</p> <p>Enable or disable the notification function about when the platen roller needs to be replaced.</p> <p>Initial setting : Disabled Setting options : Enabled, Disabled</p> <p>Enabled : Enable the notification function. Disabled : Disable the notification function.</p>	

Platen Interval	
<p>System > Notifications > Change Platen> Platen Interval</p> <p>Set the notification interval about when the platen roller needs to be replaced. When the print distance after the counter is reset reaches to the set value, a status icon for notifications is displayed. You can change settings only if you have selected Enabled in the Change Platen> Change Platen.</p> <p>Initial value : 30 km Setting range : 1 to 30 km</p> <hr/> <p> Note For details on notifications, see "3.4 Notifications" (page 139).</p>	

Sound			
<p>System > Sound</p> <p>Set the buzzer sound.</p>			
1	<table border="1"> <tr> <td>Error Sound</td> <td>Set the buzzer volume for the error sound.</td> </tr> </table>		Error Sound
Error Sound	Set the buzzer volume for the error sound.		

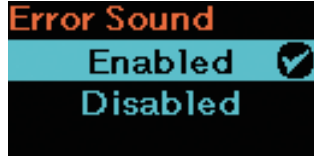
Error Sound	
<p>System > Sound > Error Sound</p> <p>Set the buzzer volume for the error sound.</p> <p>Initial setting : Enabled Setting options : Enabled, Disabled</p>	

Energy Saving		
System > Energy Saving		
To set the energy saving mode, the setting items are as follows:		
1	Sleep Timeout	Set the period before the printer enters Sleep Timeout mode.
2	Auto Power-Off	Set the time to power off the printer when the printer has not been operated within the specified period.

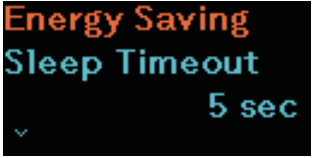

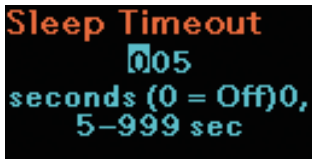

Sleep Timeout	
System > Energy Saving > Sleep Timeout	
Set the period before the printer enters Sleep Timeout mode.	
Initial value : 5 sec.	
Setting range : 0 or 5 to 999	
<p><input type="checkbox"/> Note</p> <p>If you set the item to 0, the Sleep Timeout function is set to off.</p>	
<p>Conditions Not to Transit to the Sleep Timeout Mode</p> <ul style="list-style-type: none"> • During adjustment, setting, or download modes • When the printer is in low-battery status (Error 1043) • When no battery is installed (Error 1060) • When the temperature in the printer exceeds the tolerance range (error 1022, 1064, 1065) 	
<p>Conditions to Return from the Sleep Timeout Mode</p> <ul style="list-style-type: none"> • When the cover is closed and opened • While the printer receives the data • When any printer button is pressed • When the battery is removed with an AC adapter connected (Error 1060) • When an AC adapter is removed or connected. • When the USB cable is removed or connected. • When charging is completed • When the printer detects the low battery status (Error 1043) • When the Auto Power-Off mode is selected <p>*When you press a button during the Sleep Timeout mode, the printer returns to the normal mode. Press the button again after the printer returns to the normal mode.</p> <p>*When the printer transits to the Sleep Timeout mode during wireless LAN connection, the printer returns to the normal mode after it receives the data. However, if you move the printer temporarily outside the access point range, the printer is disconnected with the wireless LAN connection. To establish the wireless LAN connection again, press any button to release the Sleep Timeout mode. (Wireless LAN model)</p>	

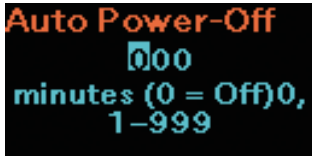

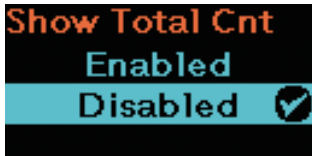

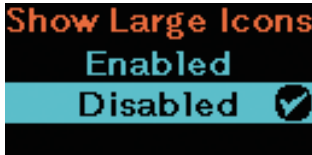
Auto Power-Off	
<p>System > Energy Saving > Auto Power-Off</p> <p>Set the time to power off the printer when the printer has not been operated within the specified period.</p> <p>Initial value : 0 minute (Off) Setting range : 0 to 999 minutes</p> <hr/> <p> Note If you set the item to 0, the Auto Power-Off function is set to off.</p> <hr/> <p>Conditions Not to Transit to the Auto Power-Off Mode</p> <ul style="list-style-type: none"> • During adjustment, setting, or download modes • During charging • When the temperature in the printer exceeds the tolerance range (error 1065) 	

Show Total Cnt	
<p>System > Show Total Cnt</p> <p>Enable or disable the indication of the total print count. If set to Enabled, the total print count is displayed on both the printing (online) and offline (stop) screens. The number in the brackets to the right of QTY is the total print count.</p> <p>Initial setting : Disabled Setting options : Enabled, Disabled</p> <p>Enabled : Enable the indication of the total print count. Disabled : Disable the indication of the total print count.</p> <hr/> <p> Note When you power off the printer, the count resets to 0.</p> <hr/>	



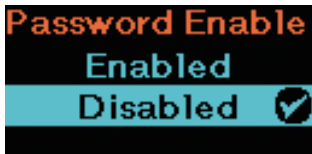

Show Large Icons	
<p>System > Show Large Icons</p> <p>Enable or disable the large icons display.</p> <p>Initial setting : Disabled Setting options : Enabled, Disabled</p>	

Password			
System > Password			
To set the password, the setting items are as follows:			
1	Password Enable		Enable or disable the password function.
2	Install Security		Enable or disable the password input for the package file download.
3	NFC Security		Set the security when writing the settings to the NFC interface.
4	Change Pwd	Change the password.	

Password Enable	
System > Password > Password Enable	
<p>Enable or disable the password function. If you have set the password to Enabled, the specified password is required when you enter the Settings menu after starting up the printer or after a certain period from switching from the settings mode to the normal mode.</p> <p>Initial setting : Disabled Setting options : Enabled, Disabled</p> <p>Enabled : Enable the password setting. Disabled : Disable the password setting.</p> <hr/> <p> Note The default password is 0310. You can change the password in Password > Change Pwd > level1.</p> <hr/>	

Install Security	
<p>System > Password > Install Security</p> <p>Enable or disable the password input in downloading the package (pkg) file.</p> <p>Initial setting : Disabled</p> <p>Setting options : None, USB, Always</p> <p>Disabled: No password is required when you download the package file.</p> <p>USB : The password is required when you download the package file from the USB memory.</p> <p>Always: The password is required when you download the package file both from the computer or the USB memory.</p>	

NFC Security	
<p>System > Password > NFC Security</p> <p>Make the security settings for when writing the settings to the NFC interface.</p> <p>Initial value : None</p> <p>Setting options : None, Confirm, Password</p> <p>None : No security setting is made.</p> <p>Confirm : The confirmation message is shown before the settings are written to the NFC interface.</p> <p>Password : You need to enter the password when writing to the NFC interface.</p>	

Change Pwd	
<p>System > Password > Change Pwd</p> <p>Change the password. You can enter 4 to 32 digits numbers only.</p> <p>Setting options : admin, manager, level1</p> <hr/> <p> Notes</p> <ul style="list-style-type: none"> • The admin and manager passwords are for factory and maintenance personnel. You cannot change these passwords. • The default value for level1 is 0310. <hr/> <p>Reset Passwords</p> <p>If you have forgotten the customized password, you can reset it back to the default password.</p> <ol style="list-style-type: none"> 1. Power off the printer, and then power on the printer. 2. When the SATO logo is displayed on the screen, press and hold the  button and  button simultaneously, and then release the buttons when a buzzer sounds. 3. All the passwords are reset to default passwords, and the normal screen is displayed. <ul style="list-style-type: none"> • The above procedures, as a temporary solution, allow users to access the setting mode with the default password. • After you access to the setting mode with the default password, set the password again. 	

2.6.6 Tools Menu

In the Tools menu, the setting items are as follows:

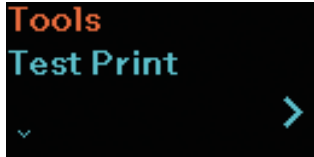
Tools			
1	Test Print	Perform a test print.	
2	HEX-Dump	Set the HEX-Dump mode and how to manage the received buffer data and log files.	
3	Reset	Initialize printer settings.	
4	Service	These are the setting items for service. Strictly for SATO authorized service personnel use.	
5	Factory	These are the setting items for service. Strictly for SATO authorized service personnel use.	
6	Wi-Fi Site Survey	Make a survey of the wave strength for each access point and display or print the survey results.	

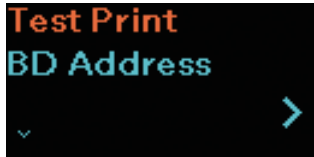

Test Print			
Tools > Test Print			
To perform a test print, the setting items are as follows:			
1	BD Address	Perform the BD Address test print with QR code and Code 39.	
2	Factory	Perform the factory test print.	
3	Configure List	Print the configuration information of the printer.	
4	Configure QR	Print the configuration information with a QR code.	
5	Paper Sensor	Print the wave form of media sensor level.	

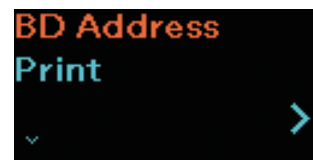
BD Address		
Tools > Test Print> BD Address		
To perform the BD Address test print, the setting items are as follows:		
1	Print	Perform the test print. To stop the test print, press the ▶ /→ button or ↵/← button.
2	Pitch	Adjust the print position. Initial value : 0 dot Setting range : -30 to 30 dots
3	Offset	Adjust the stop position of media. Initial value : 0 dot Setting range : -30 to 30 dots
4	Darkness Adjust	Fine tune the print darkness of the print. Initial value : 50 Setting range : 0 to 99 dot <hr/> <input type="checkbox"/> Note 0 is the lightest and 99 is the darkest. <hr/>
<input type="checkbox"/> Notes <ul style="list-style-type: none"> • The values of Pitch, Offset and Darkness Adjust set in the BD Address menu are reflected to the same item settings in the Factory menu, Configure List menu, Configure QR menu and Paper Sensor menu. • The values of Pitch, Offset and Darkness Adjust set in the BD Address menu are reflected to the same item settings in the Adjustment mode (page 63). 		



Factory		
Tools > Test Print > Factory		
To perform the factory test print, the setting items are as follows:		
1	Print	Perform the test print. To stop the test print, press the ► /→ button or ⏏/⏏ button.
2	Pitch	Adjust the print position. Initial value : 0 dot Setting range : -30 to 30 dots
3	Offset	Adjust the stop position of media. Initial value : 0 dot Setting range : -30 to 30 dots
4	Darkness Adjust	Fine tune the print darkness of the print. Initial value : 50 Setting range : 0 to 99 dot <hr/> <input type="checkbox"/> Note 0 is the lightest and 99 is the darkest. <hr/>
<hr/> <input type="checkbox"/> Notes <ul style="list-style-type: none"> • The values of Pitch, Offset and Darkness Adjust set in the Factory menu are reflected to the same item settings in the BD Address menu, Configure List menu, Configure QR menu and Paper Sensor menu. • The values of Pitch, Offset and Darkness Adjust set in the Factory menu are reflected to the same item settings in the Adjustment mode (☞ page 63). <hr/>		



Configure List		
Tools > Test Print > Configure List		
To perform the Configure List test print, the setting items are as follows:		
1	Print	Perform the test print. To stop the test print, press the ► /→ button or ↵/← button.
2	Label Length	Set the length of one sheet of media used for the test print. Initial value : 800 dot Setting range : 400 to 1600 dots
3	Pitch	Adjust the print position. Initial value : 0 dot Setting range : -30 to 30 dots
4	Offset	Adjust the stop position of media. Initial value : 0 dot Setting range : -30 to 30 dots
5	Darkness Adjust	Fine tune the print darkness of the print. Initial value : 50 Setting range : 0 to 99 dots <hr/>  Note 0 is the lightest and 99 is the darkest. <hr/>
<hr/>  Notes <ul style="list-style-type: none"> • The values of Label Length, Pitch, Offset and Darkness Adjust set in the Configure List menu are reflected to the same item settings in the BD Address menu, Factory menu, Configure QR menu and Paper Sensor menu. • The values of Pitch, Offset and Darkness Adjust set in the Configure List menu are reflected to the same item settings in the Adjustment mode (page 63). <hr/>		



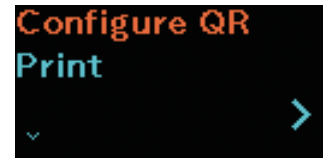

Configure QR		
Tools > Test Print > Configure QR		
To perform the Configure QR test print, the setting items are as follows:		
1	Print	Perform the test print. To stop the test print, press the ► /→ button or ⏏/← button.
2	Label Length	Set the length of one sheet of media used for the test print. Initial value : 800 dot Setting range : 400 to 1600 dots
3	Pitch	Adjust the print position. Initial value : 0 dot Setting range : -30 to 30 dots
4	Offset	Adjust the stop position of media. Initial value : 0 dot Setting range : -30 to 30 dots
5	Darkness Adjust	Fine tune the print darkness of the print. Initial value : 50 Setting range : 0 to 99 dots <hr/> <input type="checkbox"/> Note 0 is the lightest and 99 is the darkest. <hr/>
<hr/> <input type="checkbox"/> Notes <ul style="list-style-type: none"> • The values of Label Length, Pitch, Offset and Darkness Adjust set in the Configure QR menu are reflected to the same item settings in the BD Address menu, Factory menu, Configure List menu and Paper Sensor menu. • The values of Pitch, Offset and Darkness Adjust set in the Configure QR menu are reflected to the same item settings in the Adjustment mode (page 63). <hr/>		



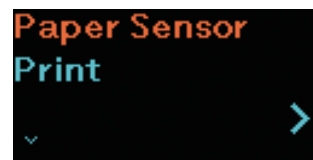

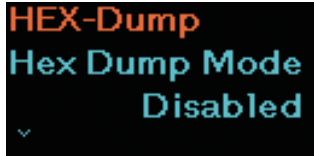
Paper Sensor		
Tools > Test Print > Paper Sensor		
To perform the Paper Sensor test print, the setting items are as follows:		
1	Print	Perform the test print. To stop the test print, press the ▶ /→ button or ⏏/← button.
2	Label Length	Set the length of one sheet of media used for the test print. Initial value : 800 dot Setting range : 400 to 1600 dots
3	Pitch	Adjust the print position. Initial value : 0 dot Setting range : -30 to 30 dots
4	Offset	Adjust the stop position of media. Initial value : 0 dot Setting range : -30 to 30 dots
5	Darkness Adjust	Fine tune the print darkness of the print. Initial value : 50 Setting range : 0 to 99 dots <hr/> <input type="checkbox"/> Note 0 is the lightest and 99 is the darkest. <hr/>
<hr/> <input type="checkbox"/> Notes <ul style="list-style-type: none"> • The values of Label Length, Pitch, Offset and Darkness Adjust set in the Paper Sensor menu are reflected to the same item settings in the BD Address menu, Factory menu, Configure List menu and Configure QR menu. • The values of Pitch, Offset and Darkness Adjust set in the Paper Sensor menu are reflected to the same item settings in the Adjustment mode (page 63). <hr/>		





HEX-Dump			
Tools > HEX-Dump			
To save the received buffer data, the setting items are as follows:			
1	Hex Dump Mode		Enable or disable the Hex Dump mode.
2	Buffer Dump		Save the received buffer data to the printer.
3	Log Files	Manage the log files of the received data created in the HEX-Dump mode and Buffer Dump.	

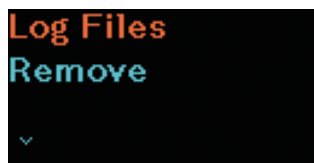

Hex Dump Mode	
Tools > HEX-Dump > Hex Dump Mode	
<p>Enable or disable the Hex Dump mode.</p> <p>If you set the Hex Dump mode to Enabled, the printer prints the received data and at the same time creates a file of the received data inside hexdump/.</p> <p>Initial setting : Disabled</p> <p>Setting options : Enabled, Disabled</p>	
<hr/> <p> Notes</p> <ul style="list-style-type: none"> • If you set the Hex Dump mode to Enabled, HEX is added to the status icons. • You can save a maximum of ten received data files for each type of interface. Depending on the file size, the number of files you can save is less than ten. • The details of the files created inside hexdump/ are as follows: <ul style="list-style-type: none"> • BT00xx.bin: Received data through Bluetooth. • WIFI00xx.bin: Received data through wireless LAN. • USB00xx.bin: Received data through USB. • When the received data size reaches to 1024 KB or the status without receiving data lasts for 60 seconds, the file is saved. • You can print or delete files from the Log Files menu. <hr/>	
	

Buffer Dump	
<p>Tools > HEX-Dump > Buffer Dump</p> <p>Save the receive buffer data to the buff/ folder of the printer. Buffer dump is available only if you have set the Hex Dump Mode to Disabled.</p> <hr/> <p> Notes</p> <ul style="list-style-type: none"> • The data files of the receive buffer are created for each type of interface. • The details of the file created inside buff/ are as follows: <ul style="list-style-type: none"> • BT0001.bin: Received data through Bluetooth. • WIFI0001.bin: Received data through wireless LAN. • USB0001.bin: Received data through USB. • If you perform the Buffer Dump again, the existing file is overwritten. • You can print or delete files from the Log Files menu. <hr/>	

Log Files							
<p>Tools > HEX-Dump > Log Files</p> <p>To manage the files of the received data created in the HEX-Dump mode and Buffer Dump, the setting items are as follows:</p>							
<table border="1"> <tbody> <tr> <td>1</td> <td>Remove</td> <td>Delete the files of the received data.</td> </tr> <tr> <td>2</td> <td>Print</td> <td>Print files of the received data.</td> </tr> </tbody> </table>	1	Remove	Delete the files of the received data.	2	Print	Print files of the received data.	
1	Remove	Delete the files of the received data.					
2	Print	Print files of the received data.					



Remove	
<p>Tools > HEX-Dump > Log Files > Remove</p> <p>Delete the files of the received data as follows:</p> <ol style="list-style-type: none"> 1. Select the file type you want to delete. <ul style="list-style-type: none"> • buff/: The buffer data saved after you perform the Buffer Dump. • hexdump/: The received data created through Hex Dump Mode. 2. Select the file you want to delete. 	

Print	
<p>Tools > HEX-Dump > Log Files > Print</p> <p>Print the files of the received data as follows:</p> <ol style="list-style-type: none"> Select the file type you want to print. <ul style="list-style-type: none"> • buff/: The buffer data saved after you perform the Buffer Dump. • hexdump/: The received data created through Hex Dump Mode. Select the file you want to print. 	

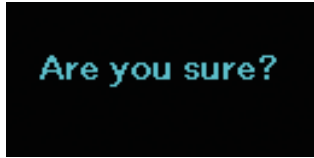
Select										
<p>Tools > Reset > Select</p> <p>To select the items to be initialized, the items are as follows:</p> <table border="1"> <tr> <td>1</td> <td>Data</td> <td>Initialize the data saved in the printer.</td> </tr> <tr> <td>2</td> <td>Data & Set.</td> <td>Initialize the data and setting values of the printer.</td> </tr> <tr> <td>3</td> <td>Settings</td> <td>Initialize the setting values of the printer.</td> </tr> </table>	1	Data	Initialize the data saved in the printer.	2	Data & Set.	Initialize the data and setting values of the printer.	3	Settings	Initialize the setting values of the printer.	
1	Data	Initialize the data saved in the printer.								
2	Data & Set.	Initialize the data and setting values of the printer.								
3	Settings	Initialize the setting values of the printer.								
 <p>It is generally not necessary to perform the initialization. Doing so could change the print conditions.</p>										

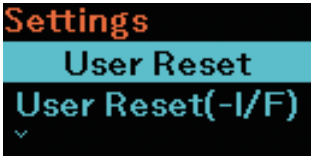
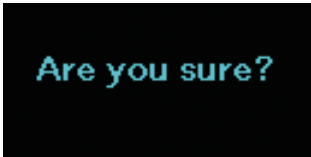
Data	
<p>Tools > Reset > Select > Data</p> <p>Initialize the data saved in the printer. The data to be initialized are the fonts and graphics registered in the printer.</p>	

Data & Settings	
<p>Tools > Reset > Select > Data & Settings</p> <p>Initialize the data and setting values of the printer. The data to be initialized are the fonts and graphics registered in the printer.</p> <p>Setting options : User Reset, User Reset (-I/F), Factory Reset, Factory Reset (-I/F), Interface, Printing</p> <p>User Reset : Initialize the data and setting values. User Reset (-I/F) : Initialize the data and setting values that are not included in the Interface menu. Factory Reset : Initialize to the status after factory shipment. Factory Reset (-I/F) : Initialize the items that are not included in the Interface menu to the status after factory shipment. Interface : Initialize the data and setting values in the Interface menu. Printing : Initialize the data and setting values in the Printing menu.</p> <hr/> <p> Note For the initial value for each setting item, see "2.7 List of Initial Value" (page 122).</p>	 

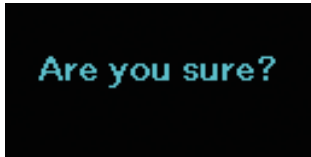
Settings	
<p>Tools > Reset > Select > Settings</p> <p>Select the setting items of the printer to be initialized.</p> <p>Setting options : User Reset, User Reset (-I/F), Factory Reset, Factory Reset (-I/F), Interface, Printing</p> <p>User Reset : Initialize the setting values. User Reset (-I/F) : Initialize the setting values that are not included in the Interface menu. Factory Reset : Initialize to the status after factory shipment. Factory Reset (-I/F) : Initialize the items that are not included in the Interface menu to the status after factory shipment. Interface : Initialize the setting values in the Interface menu. Printing : Initialize the setting values in the Printing menu.</p> <hr/> <p> Note For the initial value for each setting item, see "2.7 List of Initial Value" (page 122).</p>	 

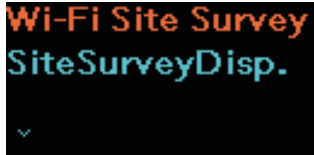
Wi-Fi Site Survey (PW208NX only : Wireless LAN model)	
Tools > Wi-Fi Site Survey	
Make a survey of the wave strength for each access point and display or print the survey results.	
1	SiteSurveyDisp.
2	SiteSurveyPrint
	

2.6.7 Information Menu

In the Information menu, there are display items as follows:

In the Information menu, you cannot change a setting in the display items.

Information		
1	Build Version	Shows the firmware version.
2	Applications	Shows the versions of the installed applications in the printer.
3	Installation Log	Shows the installation log date. (Not visible without log data)
4	Print Module	Shows the print module information.
5	Sensor Module	Shows the Sensor module information.
6	Counters	Shows the counter information.
7	Active printing	Shows the setting information of the active printing operations.
8	IPv4 Address	Shows the IPv4 Address. (Wireless LAN model)
9	IPv6 Address	Shows the IPv6 Address. (Wireless LAN model) This item is not displayed when Wi-Fi Direct is selected.
10	Wi-Fi MAC	Shows MAC address of the wireless LAN. (Wireless LAN model)
11	Wi-Fi Region	Shows the region information of the wireless LAN. (Wireless LAN model)
12	Wi-Fi Status	Set the wireless LAN Status. (Wireless LAN model)
13	Wi-Fi Direct	Shows the connection information of the Wi-Fi Direct only if the printer is connected to the Wi-Fi Direct.
14	Wi-Fi Versions	Shows the wireless LAN Version. (Wireless LAN model)

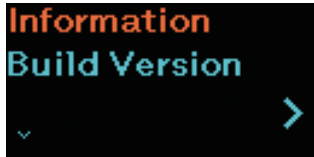

Build Version		
Information > Build Version		
Shows the information and version of this printer.		
1	Name	Shows the name of the build version.
2	Date	Shows the date of the build version.
3	Checksum	Shows the checksum of the build version.
4	Kernel Version	Shows the kernel version.
5	Boot Version	Shows the boot version.



Boot Version		
Information > Build Version > Boot Version		
Shows the boot version of this printer as follows:		
1	Disks	Shows the Disks.
2	Warp!!-mode	Enable or disable the Warp!!-mode.
3	Release Date	Shows the build date of the boot version.

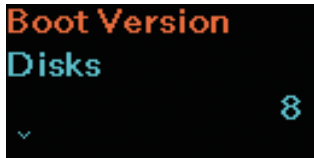

Print Module		
Information > Print Module		
Shows the information about the print module of this printer as follows:		
1	Boot	Shows the Boot firmware version.
2	Main	Shows the Main firmware version.

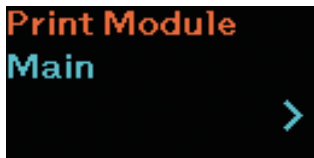

Main		
Information > Print Module > Main		
Shows the information about the main firmware of this printer as follows:		
1	Name	Shows the Main firmware name.
2	Release Date	Shows the Main firmware release date.

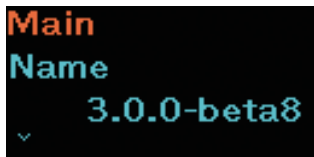

Sensor Module		
Information > Sensor Module		
Shows the information about the Sensor Module of this printer.		
1	Boot	Shows the Boot firmware version.
2	Main	Shows the Main firmware version.



Boot		
Information > Sensor Module > Boot		
Shows the information about the boot firmware of this printer as follows:		
1	Name	Shows the Boot firmware name.
2	Release Date	Shows the Boot firmware release date.
3	Checksum	Shows the Boot firmware checksum.

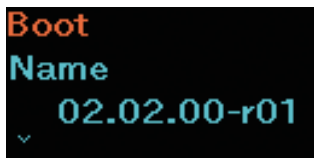

Main		
Information > Sensor Module > Main		
Shows the information about the main firmware of this printer as follows:		
1	Name	Shows the Main firmware name.
2	Release Date	Shows the Main firmware release date.
3	Checksum	Shows the Main firmware checksum.

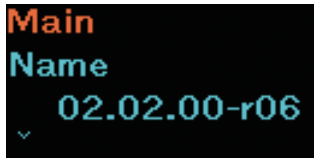

Counters		
Information > Counters		
Shows the counter information of this printer as follows:		
1	Print head	Shows the head counter information of this printer.



Head		
Information > Counters > Head		
Shows the head counter information of this printer.		
1	Life	Shows the current print distance.
2	Head 1	Head 1 shows the current print distance.
3	Head 2	When you replace the print head, the head counter of Head 1 is transferred to Head 2 and Head 1 starts to count from 0 again.
4	Head 3	

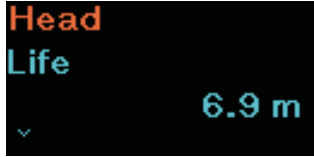

Active printing		
Information > Active Printing		
Shows the setting information of the active printing operations as follows:		
1	Print Mode	Shows the current Print Mode.
2	Sensor Type	Shows the type of media pitch sensor being used.



Wi-Fi Direct		
Information > Wi-Fi Direct		
Shows the connection information of the Wi-Fi Direct only if the printer is connected to the Wi-Fi Direct.		
1	SSID	Shows the SSID.
2	Role	Shows the Wi-Fi Direct connection status with the following item: GO: Group Owner
3	Device Address	Shows the device address.
4	IP Address	Shows the IP Address.
5	Passphrase	Shows the passphrase.



2.7 List of Initial Value

The initial value refers to the setting value of the printer when it was shipped from the factory.

If you reset the printer, the setting values of the printer change back to the factory default values.

The tables below show the initial value of each setting item and type of reset that changes the value back to the initial value.



It is generally not necessary to perform the initialization.
Initialization may change the print conditions.

2.7.1 Printing Menu

Setting options	Initial Setting/Value	User Reset	Factory Reset
Label Length	1760 dots	<input type="radio"/>	<input type="radio"/>
Label Width	440 dots	<input type="radio"/>	<input type="radio"/>
Auto Measure	Disabled	<input type="radio"/>	<input type="radio"/>
Speed	4 ips (inches/sec)	<input type="radio"/>	<input type="radio"/>
Print Mode	Tear-Off	<input type="radio"/>	<input type="radio"/>
Sensor Type	PW208NX: I-Mark PW208mNX: None	<input type="radio"/>	<input type="radio"/>
Peeling Setting (PW208NX only)	–	–	–
Backfeed	Before	<input type="radio"/>	<input type="radio"/>
Sensor Type	I-Mark	–	–
Darkness Range	A	<input type="radio"/>	<input type="radio"/>
Darkness	5	<input type="radio"/>	<input type="radio"/>
Imaging	–	–	–
Vertical	0 dot	<input type="radio"/>	<input type="radio"/>
Horizontal	0 dot	<input type="radio"/>	<input type="radio"/>

Setting Items	Initial Setting/Value	User Reset	Factory Reset
Advanced	–	–	–
Calibrate	Auto-Calibration	–	–
Auto-Calibration	PW208NX: Gap + I-Mark	No	No
	PW208NX: I-Mark	No	No
Gap Sensor	–	–	–
Emission Level	3	No	No
Receiving Level	64	No	No
Slice Level	0.0 V (Auto)	No	No
I-Mark Sensor	–	–	–
Emission Level	3	No	No
Receiving Level	64	No	No
Slice Level	0.0 V (Auto)	No	No
Head Check	All	○	○
Head Chk Mode	Always	○	○
Every Page	1	○	○
Chk Media size	Disabled	○	○
Adjustments	–	–	–
Offset	0 dot	No	No
Pitch	0 dot	No	No
Darkness Adjust	50	No	No
Start Online	Enabled	○	○
Feed After Error	Disabled	○	○
Feed At P-On	Disabled	○	○
Finisher Feed	0 dot	○	○
Paper End Sensor (PW208NX only)	Using I-mark:	○	○
Prioritize	Commands	○	○
Reprint	Disabled	○	○
Print End Pos. (Print End Position)	0 dot	○	○
Dispenser Mode	PW208NX: Auto PW208mNX: None	○	○

2.7.2 Interface Menu

Setting Items	Initial Setting/Value	User Reset	Factory Reset
Network	–	–	–
Settings	–	–	–
Wi-Fi	–	–	–
IPv4	–	–	–
Mode	DHCP	Yes/comm`	Yes/comm`
DHCP	–	Yes/comm`	Yes/comm`
IP Address	000.000.000.000	Yes/comm`	Yes/comm`
Netmask	255.255.255.0	Yes/comm`	Yes/comm`
Gateway	000.000.000.000	Yes/comm`	Yes/comm`
DNS	000.000.000.000	Yes/comm`	Yes/comm`
IPv6	–	–	–
Mode	Disabled	Yes/comm`	Yes/comm`
DHCP	–	Yes/comm`	Yes/comm`
IP Address	::	Yes/comm`	Yes/comm`
Prefix Length	64	Yes/comm`	Yes/comm`
Gateway	::	Yes/comm`	Yes/comm`
DNS	::	Yes/comm`	Yes/comm`
Proxy	–	–	–
Enabled	Disabled	Yes/comm`	Yes/comm`
Server	–	Yes/comm`	Yes/comm`
Exclude	–	Yes/comm`	Yes/comm`
Wi-Fi Direct	–	–	–
Name	SATO PRINTER	Yes/comm`	Yes/comm`
SSID	SATO PRINTER	Yes/comm`	Yes/comm`
Hidden SSID	Enabled	Yes/comm`	Yes/comm`
Mode	Ad-hoc	Yes/comm`	Yes/comm`
Channel	6	Yes/comm`	Yes/comm`
Security	None	Yes/comm`	Yes/comm`
WEP Conf.	--	–	–
Authentication	Open System	Yes/comm`	Yes/comm`
Key Index	1	Yes/comm`	Yes/comm`

*: These settings and values of communications settings in usable status are not reset when performing Factory reset.

Setting Items	Initial Setting/Value	User Reset	Factory Reset
WPA Conf.	–	–	–
WPA Authentication	Personal (PSK)	Yes/comm*	Yes/comm*
EAP Conf.	–	–	–
EAP Mode	FAST	Yes/comm*	Yes/comm*
Inner Method	MSCHAPv2	Yes/comm*	Yes/comm*
Inner Method	MSCHAPv2	Yes/comm*	Yes/comm*
Inner Method	MSCHAPv2	Yes/comm*	Yes/comm*
Username	–	Yes/comm*	Yes/comm*
Anon.Outer ID	–	Yes/comm*	Yes/comm*
Verify Server Cert.	Enabled	Yes/comm*	Yes/comm*
PAC Auto Provisioning	Disabled	Yes/comm*	Yes/comm*
Services	–	–	–
Port	–	–	–
Port1	1024	Yes/comm*	Yes/comm*
Port2	1025	Yes/comm*	Yes/comm*
Port3	9100	Yes/comm*	Yes/comm*
Flow Control	Status4	Yes/comm*	Yes/comm*
LPD	Enabled	Yes/comm*	Yes/comm*
DNS Lookup	Disabled	Yes/comm*	Yes/comm*
FTP	Disabled	Yes/comm*	Yes/comm*
FTP Timeout	Disabled	Yes/comm*	Yes/comm*
Advanced	–	–	–
ARP Announce	–	–	–
Additional	Enabled	Yes/comm*	Yes/comm*
Periodic	300 sec.	Yes/comm*	Yes/comm*

*: These settings and values of communications settings in usable status are not reset when performing Factory reset.

Starting Up the Printer

Setting Items	Initial Setting/Value	User Reset	Factory Reset
USB	–	–	–
Flow Control	Status4	Yes/comm*	Yes/comm*
Bluetooth	–	–	–
Enable	Enabled	Yes/comm*	Yes/comm*
Name	SATO PRINTER_XXXXXXXXXX (xxx: BD address is displayed.)	Yes/comm*	Yes/comm*
PIN Code	0000	Yes/comm*	Yes/comm*
BD Address	XXXXXXXXXX	Yes/comm*	Yes/comm*
Firm Version	spp3_vX.YY	Yes/comm*	Yes/comm*
Host BD addr	–	Yes/comm*	Yes/comm*
IAP Ready	Enabled	–	–
iOS Reconnect	Disabled	Yes/comm*	Yes/comm*
Authentication	None	Yes/comm*	Yes/comm*
ISI	2048	Yes/comm*	Yes/comm*
ISW	18	Yes/comm*	Yes/comm*
PSI	144	Yes/comm*	Yes/comm*
PSW	18	Yes/comm*	Yes/comm*
Give BD Address	Enabled	Yes/comm*	Yes/comm*
IO Compatible	Disabled	Yes/comm*	Yes/comm*
CRC Mode	Disabled	Yes/comm*	Yes/comm*
Flow Control	Status4	Yes/comm*	Yes/comm*
NFC	–	–	–
I/F Enable	Enabled	Yes/comm*	Yes/comm*
Ignore CR/LF	Disabled	Yes/comm*	Yes/comm*
Ignore CAN/DLE	Disabled	Yes/comm*	Yes/comm*

*: These settings and values of communications settings in usable status are not reset when performing Factory reset.

2.7.3 Battery Menu

Setting Items	Initial Setting/Value	User Reset	Factory Reset
Eco Charge	Disabled	<input type="radio"/>	<input type="radio"/>
Full Charge P-Off	Enabled	<input type="radio"/>	<input type="radio"/>

2.7.4 Applications Menu

Setting Items	Initial Setting/Value	User Reset	Factory Reset
Protocol	SBPL	<input type="radio"/>	<input type="radio"/>
SBPL	–	–	–
Show Error	Disabled	<input type="radio"/>	<input type="radio"/>
Standard Code	Enabled	<input type="radio"/>	<input type="radio"/>
Orientation	Portrait	<input type="radio"/>	<input type="radio"/>
Font Settings	–	–	–
Zero Slash	Enabled	<input type="radio"/>	<input type="radio"/>
Kanji	–	–	–
Kanji Set	GB18030	<input type="radio"/>	<input type="radio"/>
Character Code	SJIS	<input type="radio"/>	<input type="radio"/>
Kanji Style	Gothic	<input type="radio"/>	<input type="radio"/>
Proportional	Enabled	<input type="radio"/>	<input type="radio"/>
Code Page	858	<input type="radio"/>	<input type="radio"/>
€	d5	<input type="radio"/>	<input type="radio"/>
Compatible	–	–	–
CODE128(C)	Disabled	<input type="radio"/>	<input type="radio"/>
Call Font/Log	Disabled	<input type="radio"/>	<input type="radio"/>
QTY Timing	Disabled	<input type="radio"/>	<input type="radio"/>
Character Pitch	Disabled	<input type="radio"/>	<input type="radio"/>
SZPL	–	–	–
Label	–	–	–
Shift	0 dot	<input type="radio"/>	<input type="radio"/>
Top	0 dot	<input type="radio"/>	<input type="radio"/>
Caret	94 (^)	<input type="radio"/>	<input type="radio"/>
Delimiter	44(,)	<input type="radio"/>	<input type="radio"/>
Tilde	1266 (~)	<input type="radio"/>	<input type="radio"/>
Clock Format	(none)	<input type="radio"/>	<input type="radio"/>

2.7.5 System Menu

Setting Items	Initial Setting/Value	User Reset	Factory Reset
Regional	–	–	–
Message	English, US	○	○
Unit	dot	○	○
Notifications	–	–	–
Clean Head	–	–	–
Clean Head	Disabled	○	○
Head Interval	150 m	○	○
Change Head	–	–	–
Change Head	Disabled	○	○
Head Interval	30 km	○	○
Change Platen	–	–	–
Change Platen	Disabled	○	○
Platen Interval	30 km	○	○
Sound	–	–	–
Error Sound	Enabled	○	○
Energy Saving	–	–	–
Sleep Timeout	5 sec.	○	○
Auto Power-Off	0 minute (Off)	○	○
Show Total Cnt	Disabled	○	○
Show Large Icons	Disabled	○	○
Password	–	–	–
Password Enable	Disabled	No	No
Install Security	Disabled	○	○
NFC Security	None	○	○
Change Pwd	–	–	–
level 1	0310	No	No

2.7.6 Tools Menu

Setting Items	Initial Setting/Value	User Reset	Factory Reset
Test Print	–	–	–
BD Address	–	–	–
Pitch	0 dot	No	No
Offset	0 dot	No	No
Darkness Adjust	50	No	No
Factory	–	--	--
Pitch	0 dot	No	No
Offset	0 dot	No	No
Darkness Adjust	50	No	No
Configure List	–	–	–
Label Length	800 dot	○	○
Pitch	0 dot	No	No
Offset	0 dot	No	No
Darkness Adjust	50	No	No
Configure QR	–	–	–
Label Length	800 dot	○	○
Pitch	0 dot	No	No
Offset	0 dot	No	No
Darkness Adjust	50	No	No
Paper Sensor	–	–	–
Label Length	800 dot	○	○
Pitch	0 dot	No	No
Offset	0 dot	No	No
Darkness Adjust	50	No	No
HEX-Dump	–	--	--
Hex Dump Mode	Disabled	○	○

3

Troubleshooting

3.1 Error Message Mode

When an error occurs, a buzzer sound, red indicator on the status LED, and an error message on the display show you the error status.

3.1.1 Error Messages

In the error message mode, an error number and the procedures to clear the error appear alternately on the display.

When the machine error (Error 1001) or program error (Error 1002) occurs, an error number and two types of countermeasures procedures to clear the error are displayed.

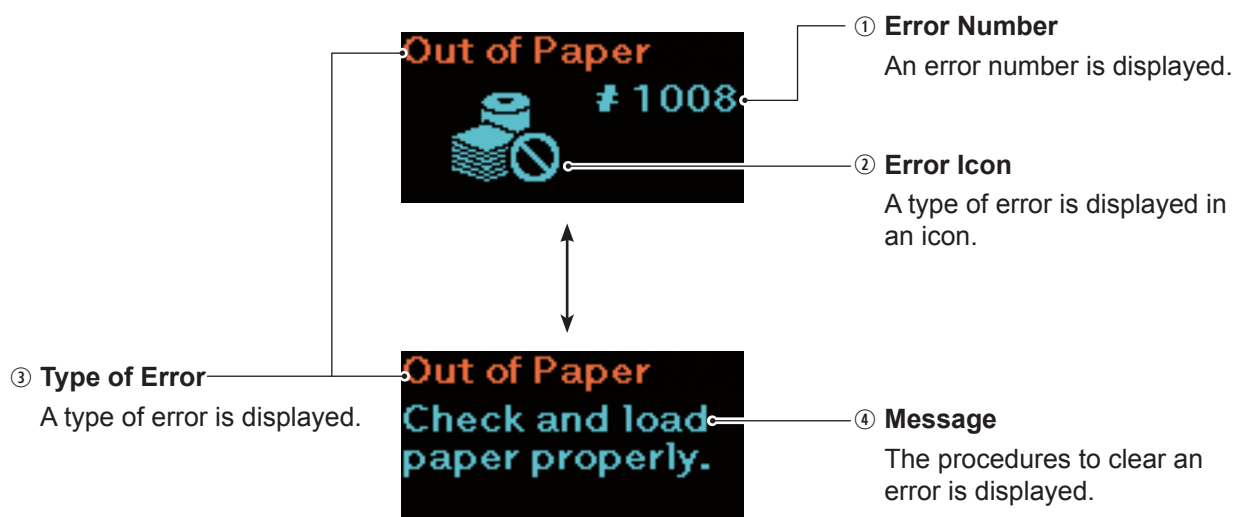

3.1.2 Status LED Indicator

In the error message mode, the status LED indicator lights in red.

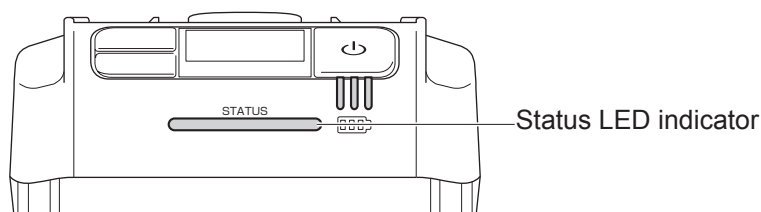





3.1.3 Error Buzzer Sound

When an error occurs, a long buzzer sounds once, or a short buzzer sounds three times.





3.2 Error List

When an error message appears on the display, the printer is in the error status. Check the error number shown on the display.







Depending on the error or warning display, causes and countermeasures may differ. To clear an error, check the types of error and warning display.

Error Message*		To clear the display	Causes	Countermeasures
① Error Number ② Error Icon	③ Type of Error ④ Message			
1001 	Machine Error 1. Power off and then on the printer. 2. In case a problem persists, contact your SATO reseller or technical support center.	Power off the printer.	1) Defective main board.	1) Contact your SATO reseller or technical support center.
1002 	Program Error 1. Power off and then on the power. 2. In case a problem persists, contact your SATO technical support center.	Power off the printer.	1) Cannot access the Flash ROM. 2) Exceeds the time for writing. 3) Other program error	1) Restart the printer. 2), 3) Contact your SATO reseller or technical support center.
1006 	Buffer Overflow Check the print data.	Power off the printer.	1) The size of the received data exceeds the size of the receive buffer. 2) The communication protocol is improper.	1), 2) Change the host program, not to send data that exceeds the size of the receive buffer.
1007 	Cover Open Close the cover.	Open and close the cover.	1) The cover is not locked. 2) Cover detection sensor has an error.	1) Lock the cover. 2) Contact your SATO reseller or technical support center.
1008 	Out of Paper Open the cover and load the media correctly.	Open and close the cover.	1) The media is not loaded. 2) The media is not loaded correctly. 3) Pitch sensor has an error.	1), 2) Load the media correctly. 3) Contact your SATO reseller or technical support center.









* : For details on error messages, see “3.1.1 Error Messages” (🔗 page 130).

Error Message*		To clear the display	Causes	Countermeasures
① Error Number ② Error Icon	③ Type of Error ④ Message			
1010 	Media Error Check the media size.	Open and close the cover.	1) The received print data is larger than the configured media size.	1) Check the media size. Specify the print data to match the configured media size.
1012 	Head Error Contact your SATO reseller or technical support center.	To clear the error message: Power off the printer. To continue printing, change the print head check conditions. To change the head check conditions: Press the ▶ /→ button and ⏪/← button simultaneously, and then Move to the Setting screen (☞ page 61).	1) Print head has an error. 2) Print head is worn out of damaged.	1), 2) Contact your SATO technical support center.
1013 	Memory Error Contact your SATO reseller or technical support center.	Power off the printer.	1) Writing to the memory fails.	1) Contact your SATO reseller or technical support center.
1014 	Memory Full Delete unwanted data from the memory.	Power off the printer.	1) There is no free space in memory.	1) Delete unwanted data from the memory.
1017 	SBPL CMD Error (SBPL command error) Caaa: <bb> : cc Check the print data.	Press the ▶ /→ button.	1) Incorrect command or parameter is detected in the print data. For how to read the command error information "Caaa:<bb>cc", see "3.2.1 How to See the Command Error Information" (☞ page 136).	1) Check the print data. Check the transmitted SBPL command. When an error cannot be cleared, contact your SATO reseller or technical support center.





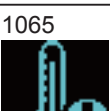



* : For details on error messages, see "3.1.1 Error Messages" (☞ page 130).

Error Message*		To clear the display	Causes	Countermeasures
① Error Number ② Error Icon	③ Type of Error ④ Message			
1022 	Printer Overheat	Stop the operation of the printer for a while.	1) The temperature of the printer has exceeded its tolerance value.	1) Stop the operation of the printer for a while to let the temperature of the printer decrease.
	Wait until the print head temperature decreases.			
1028 	GAP Not Found	Open and close the cover.	1) The gap sensor level is incorrect. 2) The sensor type is incorrect. 3) The media is meandering.	1) Contact your SATO reseller or technical support center. 2) Use the correct sensor for the media. 3) Clean and adjust the media path.
	Load the media correctly.			
1035 	I-mark Not Found	Open and close the cover.	1) The I-mark level is incorrect. 2) The sensor type is incorrect. 3) The media is meandering.	1) Contact your SATO reseller or technical support center. 2) Use the correct sensor for the media. 3) Clean and adjust the media path.
	Load the media correctly.			
1043 	Low Battery	Connect an AC adapter and charge the battery so that the low battery level is cleared. The power is automatically turned off after 30 to 40 seconds.	1) The battery is out of charge.	1) Charge or replace the battery.
	Charge the battery.			
1046 	EAP Auth Error (EAP failure)	Press the ▶ /→ button.	1) The Wi-Fi settings are incorrect.	1) Check the Wi-Fi settings.
	Change the settings.			
1047 	EAP Auth Error (EAP timeout)	Press the ▶ /→ button.	1) The Access Point (AP) setting and authentication server setting do not match.	1) Check the Access Point (AP) setting and authentication server setting.
	1) Check the AP and server settings.			
1050 	Bluetooth Error	Power off the printer.	1) Bluetooth module is defective.	1) Contact your SATO reseller or technical support center.
	Contact your SATO reseller or technical support center.			

* : For details on error messages, see “3.1.1 Error Messages” (☞ page 130).

Error Message*		To clear the display	Causes	Countermeasures
① Error Number ② Error Icon	③ Type of Error ④ Message			
1058 	CRC Check Error Check the print data.	Press the ▶ /→ button.	1) CRC has not been added to the data. 2) CRC does not match.	1), 2) Check transmitted data and interface conditions
1059 	Charging Wait until the low battery level is cleared.	Stop the operation of the printer for a while.	1) The printer is in the low battery status and is being charged.	2) Charge the printer so that it can perform printing.
1060 	No Battery Insert the battery.	Insert the battery.	1) The battery is disconnected. 2) The battery is not inserted.	1), 2) Insert the battery.
1061 	Degraded Batt. Contact your SATO reseller or technical support center.	Replace the battery.	1) The battery is degraded.	1) Replace the battery.
1063 	Battery Error Replace the battery.	Power off the printer. The power is automatically turned off after 30 to 40 seconds.	1) The battery is defective.	1) Replace the battery.
1064 	Printer Overheat Wait until the motor temperature decreases.	Stop the operation of the printer for a while.	1) The temperature of the motor has exceeded its tolerance value.	1) Stop the operation of the printer for a while to let the temperature of the printer decrease.
1065 	Printer Overheat Contact your SATO reseller or technical support center.	Power off the printer. The power is automatically turned off after 30 to 40 seconds.	1) The temperature of the printer has exceeded its tolerance value.	1) Stop the operation of the printer for a while to let the temperature of the printer decrease. 2) Contact your SATO reseller or technical support center.
1066 	Paper Jam Open the cover and load the media again.	Open the cover and load the media again.	1) The media has jammed during Linerless operation.	1) Open the cover and load the media again.
1067 	Charging Wait until charging is complete.	Wait until charging is complete.	1) You cannot power off the printer during charging.	2) Power off the printer after charging is complete.

* : For details on error messages, see “3.1.1 Error Messages” (☞ page 130).

Error Message*		To clear the display	Causes	Countermeasures
① Error Number ② Error Icon	③ Type of Error ④ Message			
1068 	WLAN Error Contact your SATO reseller or technical support center.	Press the ▶ /→ button.	1) Connecting to the WLAN module failed.	1) Contact your SATO technical support center.
1069 	Option Error Contact your SATO reseller or technical support center.	Power off the printer.	1) The Dispense, Linerless sensors, NFC connection information has been changed.	1) Contact your SATO reseller or technical support center.
1070 	Bat. Wearing out [Recommended] Replace the battery with a new one.	Press the ▶ /→ button. Or, open and close the cover.	1) The battery runs out. It is recommended that the battery should be replaced. The operation time may become short and printing quality may become poor.	1) Replace the battery.
1071 	Worn out battery [Recommended] Replace the battery with a new one.	Press the ▶ /→ button. Or, open and close the cover.	1) The battery is degraded. Replace the battery. The operation time may become short and printing quality may become poor.	1) Replace the battery.
1072 	Power Off Error Use the Print /Select button to clear an error.	Press the ▶ /→ button.	1) The printer has not been correctly powered off. (The battery is disconnected.)	1) Power off the printer, and then remove the battery. 2) Check the settings.
1075 	NFC Error Contact your SATO reseller or technical support center.	Press the ▶ /→ button.	1) NFC module is defective.	1) Contact your SATO reseller or technical support center.
1076 	NFC Command Error Failed to reflect the settings from the NFC.	Press the ▶ /→ button.	1) Invalid command in NFC.	1) Check the commands. When an error cannot be cleared, contact your SATO reseller or technical support center.
1099 	Reset The settings are initialized.	Press the ▶ /→ button.	1) The printer has not been correctly powered off. (The battery is disconnected or other problem exists.)	1) Power off the printer power correctly. 2) Check the settings.

* : For details on error messages, see “3.1.1 Error Messages” (🔗 [page 130](#)).

3.2.1 How to See the Command Error Information

When an error occurs with the printer, an error number and error content appears alternately on the screen. Check the cause and countermeasure, and then take appropriate action.



For details of the error, check the “Caaa: <bb>: cc” display on the error content screen.

- Caaa: position of error occurrence
- <bb>: error command name
- cc: error content

Location of Error Occurrence

“Caaa” in the command error message shows the location where a command error occurs.

The number of ESC commands from ESC+A is shown in “aaa”.

Note that the ESC+A command is not included in the number of ESC commands, which can be shown up to 999.

Example: When a command error is detected in the Horizontal Print Position <H> command.

```
-----: [ESC]A
C001: [ESC]V100
C002: [ESC]H99999 ←This is the location of the error.
C003: [ESC]L0202
C004: [ESC]X21,ABCDEF
C005: [ESC]Q1
C006: [ESC]Z
```

In this case, C002 is the location of the error.

Error command name

The command name is shown in “<bb>”. An error is detected in the command name.

A one-byte command name is left aligned.







Error description (codes)

The cause of a command error appears in “cc” in the error message (“Caaa: <bb>:cc”).

Description (“cc”)	Cause
01	Improper command is detected.
02	Improper parameter is received.
03	The printer failed to read the command table.
04	Improper graphic and custom designed data are detected.
05	<ul style="list-style-type: none"> • Specified registration area is inappropriate. • Tried to write to write-protected media.
06	Number specified by registration command has already been taken.
07	Exceeded the registration area. (Memory Full)
08	Data not registered.
09	The specified print start position is outside the printable area.
10	The printing image is outside the printable area. (Barcode only)
21	The QR code that cannot be generated is specified.
22	Improper ETX is received after STX has been received.

3.3 List of Warning Icons



The warning icons are displayed in order of detecting.

Warning Icons	Description	Causes	Countermeasures
	To clear an error		
	Receive buffer near full	1) Free space in the receive buffer is little.	1) Do not send the next data until printing the data finishes on the printer.
	--		
	Command error	1) A command error is detected.	1) Check the print data.
	If the next item is received or the job canceled, the warning icon is cleared.		
	Head error	1) A head error is detected.	1) Contact your SATO reseller or technical support center. The print head should be replaced.
	--		
	IP address not obtained (PW208NX only: Wireless LAN model)	1) An IP address is not obtained properly either in IPv4 or IPv6. (DHC server stops or other problem exists.)	1) Perform Network connection and Network Settings again. When Network Settings are displayed properly, restart the printer.
	Authentication chip error	1) Authentication with iOS was interrupted.	1) Wait for the icon to disappear for a while (approximately 130 seconds), and then perform Authentication with iOS again. During the authentication with iOS in process, do not power off the printer or remove the battery.
	--		
	Authentication chip malfunction	1) Bluetooth connection with iOS cannot be established because of malfunction in authentication chip.	1) Contact your SATO reseller or technical support center.
	--		

3.4 Notifications

When Notifications setting items are set to Enabled, the printer informs users of the timing for cleaning or replacing printer components after the print distance reaches to the specified value.

For details on notifications settings, see “Notifications” of “2.6.5 System Menu” ([page 99](#)).

Notification Icons	Message	Causes	Countermeasures
	To clear the display		
	Clean Print Head	1) The print distance of the printer has reached the value specified by the notification interval. For setting the interval to notify the print head cleaning, see “Head Interval” of “Clean Head” (page 100).	1) Clean the head, and reset the counter for the head interval. For cleaning methods, see “5 Cleaning the Printer” (page 141).
	When the counter is not cleared: Press the  button. When the counter is cleared: Press the  button.		

4

Optional Accessories

For purchasing the cleaning liquid for the printer, contact your SATO reseller or technical support center.

Battery

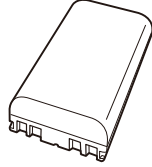

AC Adapter

Battery Charger

- 1ch Battery Charger



Charging Cradle

- 1Bay Charging Cradle

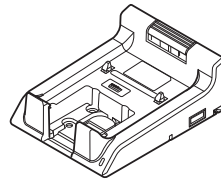

- 4Bay Charging Cradle

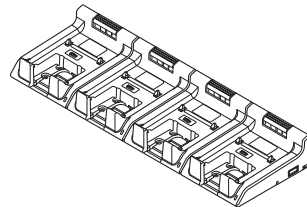

Carrying Case

Shoulder Strap

5

Cleaning the Printer

Be sure to power off the printer and remove the battery before cleaning the printer.

Platen Roller

Use the cotton cloth dabbed with cleaning liquid* to clean the platen roller softly from side to side. Rotate the platen roller to clean the whole areas.

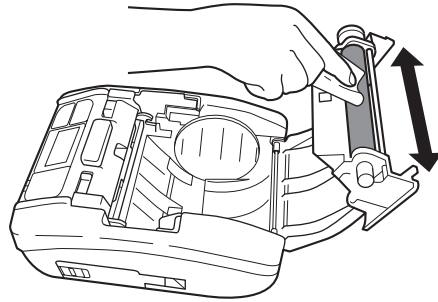

Print Head

Use the cotton cloth dabbed with cleaning liquid* to clean the print head softly from side to side.



- When cleaning the print head, be careful not to touch the cutter and have your finger or hand injured.

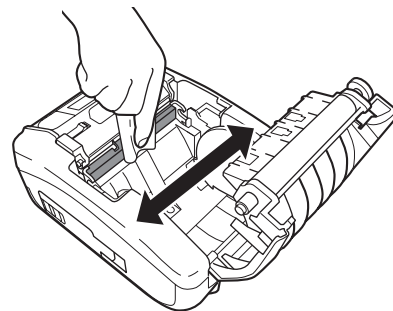

Media Guide

Use the cotton cloth dabbed with cleaning liquid* to clean the media guide softly.

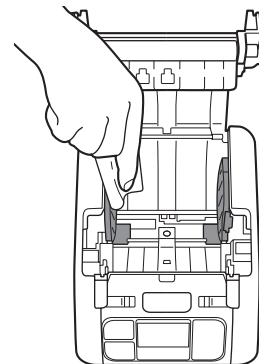



* Cleaning liquid for the printer is optional. For purchasing the cleaning liquid for the printer, contact your SATO reseller or technical support center.

6

Basic Specifications

6.1 Printer Specifications

Model Name	PW208NX	PW208mNX
Print Method	Direct Thermal	
Head Density (Resolution)	8 dots/mm (203 dpi)	
Effective Printable Area	Maximum Length 1000 mm (39.4") × Width 55 mm (2.2")	
Print Speed	3 inches to 6 inches/sec 75 mm to 152 mm/sec (In Dispenser, Linerless Mode: Maximum 4 inches (102 mm)/sec) Values may vary with print layout, ambient temperature, or remaining battery level.	
Non-printable Area	Continuous, Dispenser Pitch Direction Top: 1.5 mm (0.06"), Bottom: 1.5 mm (0.06") (Excluding liner) Width Direction Left: 1.5 mm (0.06"), Right: 1.5 mm (0.06") (Excluding liner) Linerless Pitch Direction Top: 4 mm (0.2"), Bottom: 1.5 mm (0.06") (Excluding liner) Width Direction Left: 1.5 mm (0.06"), Right: 1.5 mm (0.06") * That may affect print quality. Avoid printing on the non-printable area.	
Print Mode	Continuous, Tear-off, Dispenser, Linerless	Continuous, Tear-off, Linerless
Dimensions/Weight	Width 95 mm (3.7") × Depth 68.2 mm (2.7") × Height 128 mm (5") / Approximately 444 g (15.7 oz) (Including a battery)	Width 95 mm (3.7") × Depth 55.5 mm (2.2") × Height 109.5 mm (4.3") / Approximately 374 g (15.7 oz) (Including a battery)
Power Supply	Input Voltage : 100 to 240 V AC 50 Hz-60 Hz (AC adapter) Output voltage : DC10 V +10% - 0% ≡ 1.9 A (DC Symbol ≡) AC adapter (Optional) : ATS018T-A100 (Adapter Technology Co., LTD.)	
Battery Specifications	Lithium-ion Battery Nominal Voltage : 7.2 V Nominal Capacity : 1950 mAh Charge-discharge Cycle : Approximately 300 charge cycles or 3 years from the date of first use, whichever is earlier. Charging Time : Approximately 3 hours* Operating conditions : Continuous printing time 2 minutes. / Resting time 6 minutes.** * The charge-discharge cycle and charging time may vary depending on usage environment. ** The continuous printing time and resting time may vary depending on usage environment.	

Model Name	PW208NX	PW208mNX
Environmental Conditions (Without Media)	Standard: Operating Temperature : -15 to 50°C (5 to 122 °F) (Wireless LAN model: 0 to 50°C (32 to 122 °F)) Humidity : 10 to 85% RH (Non-condensing) (Wireless LAN model: 20 to 80% (Non-condensing)) Storage Temperature : -25 to 60°C (-13 to 140 °F) Humidity : 10 to 85% RH (Non-condensing) Charging Temperature Range : 5°C to 35°C (41 to 95 °F) In Linerless Mode: Operating Temperature : 5 to 35°C (41 to 95 °F) Humidity : 30 to 75% RH (Non-condensing) Storage Temperature : 0 to 35°C (32 to 95 °F) Humidity : 30 to 75% RH (Non-condensing)	
Interface	① Bluetooth Interface ② USB Interface ③ Wireless LAN (Wireless LAN model) ④ NFC	① Bluetooth Interface ② USB Interface ③ NFC
Optional Accessories	① Battery Pack (Identical to the supplied accessory) ② AC Adapter ③ 1ch Battery Charger ④ Carrying Case ⑤ Shoulder Strap ⑥ 1Bay Charging Cradle ⑦ 4Bay Charging Cradle	
Operation	LCD : OLED (Horizontal 128 dots × Vertical 64 dots) LED : Status (Green/Red), Battery Remaining Capacity (Green × 3) Button: Power,  /→,  /←	
Level Adjustments	Print Darkness Adjustment, Print Position Adjustment, Stop Position Adjustment	
Media Length Detection Sensor	I-mark Sensor (Reflective Type), Gap Sensor (Transmissive Type: PW208NX only)	
Barcode	UPC-A, UPC-E, JAN/EAN, CODE39, CODE93, CODE128, GS1-128(UCC/EAN128), CODABAR (NW-7), ITF, Industrial 2 of 5, Matrix 2 of 5, Customer Barcode, UPC Add-on Code, BOOKLAND, GS1 DataBar Omnidirectional, GS1 DataBar Truncated, GS1 DataBar Stacked, GS1 DataBar Stacked Omnidirectional, GS1 DataBar Limited, GS1 DataBar Expanded, GS1 DataBar Expanded Stacked * GS1 DataBar stands for RSS.	
2 D Codes	QR Code (Including Micro QR Code), Security QR, PDF417 (Including Micro PDF), MAXI Code, GS1 Data Matrix, Data Matrix (ECC200), Aztec Code	

Basic Specifications

Model Name	PW208NX	PW208mNX
<p>Bitmap Fonts</p>	<p>OCR-A: 15 × 22 dots (Alphanumeric characters, codes) OCR-B: 20 × 24 dots (Alphanumeric characters, codes)</p>	
	<p>X20: 5 × 9 dots (Alphanumeric characters, kana) X21: 17 × 17 dots (Alphanumeric characters, kana) X22: 24 × 24 dots (Alphanumeric characters, kana) X23: 48 × 48 dots (Alphanumeric characters, kana) X24: 48 × 48 dots (Alphanumeric characters, kana)</p>	
	<p>U: 5 × 9 dots S: 8 × 15 dots M: 13 × 20 dots WB: 18 × 30 dots WL: 28 × 52 dots XU: 5 × 9 dots XS: 17 × 17 dots XM: 24 × 24 dots XB: 48 × 48 dots SL: 48 × 48 dots</p>	
	<p>Markdown Font 1 : 64 × 80 dots (Numbers, “¥”) Markdown Font 2 : 52 × 80 dots (Numbers, “¥”) Markdown Font 3 : 40 × 80 dots (Numbers, “¥”) Markdown Font 4 : 104 × 92 dots (Numbers, “¥”) Markdown Font 5 : 52 × 80 dots (Numbers, “¥”) Markdown Font 6 : 40 × 80 dots (Numbers, “¥”) Markdown Font 7 : 104 × 92 dots (Numbers, “¥”) Markdown Font 8 : 88 × 92 dots (Numbers, “¥”) Markdown Font 9 : 72 × 92 dots (Numbers, “¥”) Markdown Font 10 : 56 × 92 dots (Numbers, “¥”) Markdown Font 11 : 104 × 92 dots (Numbers, “¥”) Markdown Font 12 : 88 × 92 dots (Numbers, “¥”) Markdown Font 13 : 72 × 92 dots (Numbers, “¥”) Markdown Font 14 : 56 × 92 dots (Numbers, “¥”)</p>	
	<p>Pop Font 1 : 80 × 133 dots (Numbers, “¥”, “. ”)</p>	
	<p>Kanji : 16 × 16 dots (JIS Levels 1, 2, Gothic/Mincho selectable) Kanji : 22 × 22 dots (JIS Levels 1, 2, Gothic/Mincho selectable) Kanji : 24 × 24 dots (JIS Levels 1, 2, Gothic/Mincho selectable) Kanji : 32 × 32 dots (JIS Levels 1, 2, Gothic/Mincho selectable) Kanji : 40 × 40 dots (JIS Levels 1, 2, Gothic/Mincho selectable) * Japanese (JIS0208 Compatible)</p> <p>Kanji : 16 × 16 dots (JIS Level s1 to 4, Gothic) Kanji : 22 × 22 dots (JIS Level s1 to 4, Gothic) Kanji : 24 × 24 dots (JIS Level s1 to 4, Gothic) Kanji : 32 × 32 dots (JIS Level s1 to 4, Gothic) Kanji : 40 × 40 dots (JIS Level s1 to 4, Gothic) * Japanese (JIS0213 Compatible)</p>	

Model Name	PW208NX	PW208mNX
Scalable Fonts		
Outline Fonts	Helvetica Outline Fonts	
	JIS0208-Compatible Kanji Outline Fonts	
Rasterized Fonts	SATO CG Sleek	
	SATO CG Stream	
	SATO 0 SATO Alpha Bold Condensed SATO Beta Bold Italic SATO Folio Bold SATO Futura Medium Condensed SATO Gamma SATO OCR-A SATO OCR-B SATO Sans SATO Serif SATO Symbol Set SATO Vica SATO WingBats	
	SATO Hebe Sans SATO Hebe Sans Arabic SATO Hebe Sans Thai SATO Hebe Sans Hindi SATO Gothic Traditional Chinese SATO Gothic Japanese SATO Gothic Simplified Chinese SATO Gothic Korean SATO Silver Serif SATO Mincho Traditional Chinese SATO Mincho Japanese SATO Mincho Simplified Chinese SATO Mincho Korean SATO Roman Arabic SATO Hebe Sans Hebrew	
Print Direction (Characters, Barcodes)	Characters : 0°, 90°, 180°, 270° Barcode : Parallel 1(0°), Parallel 2 (180°), Serial 1 (90°), Serial 2 (270°)	
Barcode Ratios	1:2, 1:3, 2:5, Any ratio	
Magnification (Character, Barcode)	Character : Vertical x1-36, Horizontal x1-36 Barcode : x1-12	

Basic Specifications

Model Name	PW208NX	PW208mNX
Built-in Functions	<ul style="list-style-type: none"> ① Status Return ② Graphic ③ Form Overlay (99) ④ Foreign Letter Registration (95) ⑤ Character Modification ⑥ Ruled Line ⑦ Dump List ⑧ Zero Slash Switching ⑨ Format Registration (99) ⑩ Black/white Inversion ⑪ Serial Number 	
Self-diagnosis Functions	<ul style="list-style-type: none"> ① Broken Head Element Check ② Head Open Detection ③ Paper End Detection ④ Kanji Data Check ⑤ Sensor Error Detection ⑥ Command Error Detection ⑦ Machine Error Detection ⑧ Communication Error Detection 	

6.2 Media Specifications

Model Name	PW208NX	PW208mNX
Media Type/Media Form	Media Type : Roll (Face-out) Dimension : Φ 60 mm (2.4") maximum Core : No * Use only the supply products specified by SATO.	Media Type : Roll (Face-out) Dimension : Φ 35 mm (1.4") maximum Core : No * Use only the supply products specified by SATO.
Media Size	<p>Continuous</p> <p>Length : 13 mm (0.5") to 160 mm (6.3") (16 mm (0.6") to 163 mm (6.4"))</p> <p>Width : 25.4 mm (1.0") to 55 mm (2.2")* (28.4 mm (1.1") to 58 mm (2.3"))</p> <p>* When the Print Speed is set to 5 or 6 inch/sec, use the media of 50 mm or wider.</p> <p>Tear-off</p> <p>Length : 16 mm (0.6") to 160 mm (6.3") (19 mm (0.7") to 163 mm (6.4"))</p> <p>Width : 25.4 mm (1.0") to 55 mm (2.2")* (28.4 mm (1.1") to 58 mm (2.3"))</p> <p>* When the Print Speed is set to 5 or 6 inch/sec, use the media of 50 mm or wider.</p> <p>Dispenser</p> <p>Length : 25 mm (1.0") to 160 mm (6.3") (28 mm (1.1") to 163 mm (6.4"))</p> <p>Width : 32 mm (1.3") to 55 mm (2.2") (35 mm (1.4") to 58 mm (2.3"))</p> <p>Linerless</p> <p>Length : 16 mm (0.6") to 120 mm (4.7") Width : 50 mm (2.0") to 58 mm (2.3")</p> <p>(): Inches (") are displayed in dimensions. * (): Liner size is included. * (): Liner size is included. * For Linerless media, you should make the proper settings of the printer to match your print layout conditions. For details, contact your SATO reseller or technical support center.</p>	<p>Continuous</p> <p>Length : 13 mm (0.5") to 160 mm (6.3") (16 mm (0.6") to 163 mm (6.4"))</p> <p>Width : 55 mm (2.2") (58 mm (2.3"))</p> <p>Tear-off</p> <p>Length : 16 mm (0.6") to 160 mm (6.3") (19 mm (0.7") to 163 mm (6.4"))</p> <p>Width : 55 mm (2.2") (58 mm (2.3"))</p> <p>Linerless</p> <p>Length : 16 mm (0.6") to 120 mm (4.7") Width : 58 mm (2.3")</p> <p>(): Inches (") are displayed in dimensions. * (): Liner size is included. * For Linerless media, you should make the proper settings of the printer to match your print layout conditions. For details, contact your SATO reseller.</p>

6.3 Charging Cradle (Optional) Specifications

Model Name	1Bay Charging Cradle	4Bay Charging Cradle
Dimensions	Width 120 mm (4.7") × Depth 159 mm (6.3") × Height 61 mm (2.4") (Excluding projection)	Width 480 mm (18.9") × Depth 159 mm (6.3") × Height 61 mm (2.4") (Excluding projection)
Weight	225 g (7.9 oz) (Excluding an AC adapter and AC power cord)	1300 g (7.9 oz) (Excluding an AC adapter and AC power cord)
Environmental Conditions	Operating Temperature and Humidity : 5 to 35 °C (41 to 95 °F)/ 30 to 80 %RH (Non-condensing) Storage Temperature and Humidity : -5 to 60 °C (23 to 140 °F)/ 30 to 90 %RH (Non-condensing)	
Input Voltage	AC100 to 240 V 50 Hz-60 Hz (AC adapter)	
Output Voltage	DC10V +1.0V / -0.0V 1.9A	DC12V +0.6V / -0.60V 5A
Charging time	Approximately 3 hours	
AC adapter (Optional)	ATS018T-A100N (Adaptec Technology)	LTE65ES-S2-3 (Li Tone Electronics)

7

Support

SATO provides maintenance support to ensure reliable operation of your printer.

Contact

Contact your SATO reseller or technical support center for repairs.

Extensive contact information for worldwide
SATO operations can be found on the Internet at
www.satoworldwide.com

SAATCHI